

SR-300LX

ROUGH TERRAIN CRANE

[SPECIFICATION]

■ CRANE

Description Rough terrain crane with maximum lifting capacity 30 ton

● Crane specification

Maximum lifting capacity	9.35 m Boom	30,000 kg × 3.0 m (Parts of line : 9)
	16.4 m Boom	19,000 kg × 4.0 m (Parts of line : 6)
	23.45 m Boom	12,500 kg × 5.5 m (Parts of line : 4)
	30.5 m Boom	7,500 kg × 8.0 m (Parts of line : 4)
	7.9 m Jib	3,500 kg × 75° (Parts of line : 1)
	13.0 m Jib	2,200 kg × 77° (Parts of line : 1)
	Rooster	4,000 kg
Boom length	9.35 m – 30.5 m (4 section)	
Fly jib length	7.9 m, 13.0 m (2 section, offset 5°, 25°, 45°)	
Maximum lifting height	31.2 m (Boom)	
	44.8 m (Jib)	
Hoisting line speed (winch up)	Main winch	125 m/min (at 4th layer)
	Auxiliary winch	116 m/min (at 3rd layer)
Hoisting hook speed (winch up)	Main winch	(Parts of line:9) : 13.8 m/min (at 4th layer)
	Auxiliary winch	(Parts of line:1) : 116 m/min (at 3rd layer)
Boom derricking angle	0° – 83°	
Boom derricking time	40 s / 0° – 83°	
Boom extending speed	9.35 m – 30.5 m / 93 s	
Slewing speed	2.9 min ⁻¹	
Tail slewing radius	3,500 mm	

● Equipment and structure

Boom type	Round-shaped, 4-section hydraulically telescopic type (the 3rd and 4th boom sections at the same time)	
Jib type	2 sections (2nd section of draw-out type) (offset angles 5°, 25° and 45°)	
Boom extension / retraction equipment	Two hydraulic cylinders and wire ropes used together	
Boom derricking / lowering equipment	One hydraulic cylinder of direct acting type with pressure-compensated flow control valve	
Winch system Main & Auxiliary winches	Driven by axial plunger type hoisting motor through planetary gear reduction. Controlled independently by respective operating lever. Equipped with automatic brake.	
Slewing bearing	Ball bearing type	
Outriggers	Type	Hydraulic H-beam type (with float and vertical cylinder in single unit)
	Extension width	6,600 mm (Fully extended)
		6,000 mm (Intermediately extended)
		5,000 mm (Intermediately extended)
		3,800 mm (Intermediately extended)
2,310 mm (Completely retracted)		
Wire rope for hoisting	Main winch	Diameter : 16 mm × Length : 175 m
	Auxiliary winch	Diameter : 16 mm × Length : 95 m

● Hydraulic equipment

Oil pump	4 pumps, plunger and gear type	
Hydraulic motor	Hoisting motor	Axial plunger type
	Slewing motor	Axial plunger type
Control valve	Double acting with integral check and relief valves	
Cylinder	Double acting type	
Oil reservoir capacity	500 L	

● Safety devices

ACS (Automatic Crane System with voice alarm), Slewing automatic stop system, Outrigger status detector, Boom derricking / telescoping holding valve, Overhoist prevention device, Drum lock device (on aux. winch), Winch holding valve, Automatic winch brake, Winch drum roller, Hydraulic safety valves, Outrigger lock pins, Slewing lock, Joystick control safety stop system, Hydraulic oil temperature warning device, Hydraulic oil return filter warning device

● Standard equipment

Hydraulic oil cooler, Working light (on boom, table and cab), Winch drum turning indication device

● Operator's cab

All steel welded construction, 1 person, Rubber mounted, Adjustable steering wheel, Adjustable seat, Seat belt, Front windshield wiper & washer (2 speed wiper), Roof window wiper & washer, Cigarette lighter, Ashtray, Floor mat

● Optional equipment

Winch over unwinding device, Winch drum mirror (Hoist mirror), Winch view camera, ACS outside indicator, Slewing warning buzzer, Cab heater, Cab cooler, Fan, AM/FM Radio, Fire extinguisher, Slewing warning lamp, K-COR (KATO Crane Operation Recorder), Anemometer

■ CARRIER

● Carrier specification

Maximum traveling speed	49 km/h
Grade ability	57 % (computed at G.V.W. = 26,990 kg)
Minimum turning radius (center of extreme outer tire)	4.9 m (4 wheel steer)
	8.2 m (2 wheel steer)
● Engine	
Maker	Mitsubishi
Model	6M60-TL
Type	4 cycle, 6 cylinders, water cooled, direct injection turbo-charged diesel engine with intercooling
Piston displacement	7.545 L
Max. power	200 kW at 2,600 min ⁻¹
Max. torque	785 N·m at 1,400 min ⁻¹
Diesel Fuel recommended by KATO must be used	

● Equipment and structure

Drive system	Switches between 2 wheel drive (4x2) and 4 wheel drive (4x4)	
Torque converter	Engine mounted 3 elements, 1 stage (with lock up clutch)	
Transmission	Remote mounted full automatic	
Number of speeds	4 forward & 1 reverse speed (with Hi – Low selector)	
Axles	Front	Planetary, drive/steer type
	Rear	Planetary, drive/steer type
Suspension	Front & Rear	Taper – leaf spring, Hydraulic locking device with shock absorber
	Service brake	Air-over hydraulic disk brake on 4 wheels (front and rear independent circuit)
Brake system	Parking brake	Spring applied, electrically air released parking brake mounted on front axle, internal expanding type
	Auxiliary brake	Exhaust brake
Steering	Full hydraulic power steering, Completely independent front and rear steering (with automatic rear wheel steering lock system)	
Tire size	Front	385 / 95 R25 170E ROAD
	Rear	385 / 95 R25 170E ROAD
Fuel tank capacity	300 L	
Batteries	(12 V – 120 AH) × 2	

● Safety devices

Emergency steering device, Rear wheel steering lock system (automatic), Mis-shifting prevention system, Brake fluid leak warning device, Service brake lock, Suspension lock, Engine overspeed alarm, Radiator coolant level warning device, Air filter service warning device

● Standard equipment

Centralized lubricating system

● Optional equipment

Yellow rev light, Spark arrester, Rear view camera, Right side view camera

■ GENERAL Dimensions

Overall length	11,360 mm	
Overall width	2,620 mm	
Overall height	3,475 mm	
Wheel base	3,650 mm	
Treads	Front	2,170 mm
	Rear	2,170 mm
Passenger capacity	One person	
Gross vehicle weight	Gross weight	approx. 26,990 kg
	Front weight	approx. 13,000 kg
	Rear weight	approx. 13,990 kg

● Stow the hooks in place before traveling.

● Before you use this machine, read the precautions in the instruction manual thoroughly to operate it correctly.

● KATO products and specifications are subject to improvements and changes without notice.

Notes for the lifting capacity chart

When the outriggers are used

- The lifting capacity charts are based on the jib stowed on the boom side.
- The lifting capacity chart indicates the maximum load which can be lifted by this crane provided it is level and standing on firm level ground. The values in the chart include the mass of the main hook and slings for boom operation, and auxiliary hook and slings for jib operation. [30 ton hook(mass:250kg), 4 ton hook(mass:80kg)]
Within the chart the figures in the area bordered with a thick line are based on structural limitations while other figures are determined by stability limitations.
- The working radii are the actual values allowing for boom and jib deflection. Therefore you must always operate the crane on the basis of the working radius.
- The jib working radius is based on the jib mounted on the end of the 30.5m boom. When operating at other boom lengths, use the boom angle alone as the criterion.
- Do not operate the jib when the outriggers are completely retracted.
- The lifting capacities for the over sides vary with the outriggers extension width. Therefore for each outriggers extension condition you should work according the lifting capacity chart. Use the lifting capacity chart of outriggers full extension for both front and rear areas lifting capacities.

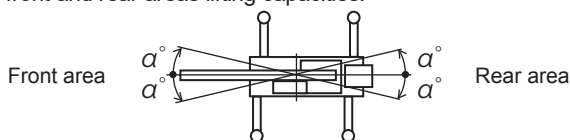

Outrigger extension status	Intermediate extension (6.0m)	Intermediate extension (5.0m)	Intermediate extension (3.8m)	Complete retraction
Area α°	35	30	20	3

- The lifting capacity of the rooster sheave is the lifting capacity of the boom minus the mass of all attached hook, slings etc. to the boom, with an upper limit of 4,000kg.
[The hook for use with the rooster sheave is the 4 ton hook(mass:80kg) with one part of line.]
- If the boom length, boom angle and/or working radius exceeds the rated value, use the lifting capacity for the rated value or for the next one, whichever gives the smaller lifting capacity.
- If you are working with the boom while the jib is rigged, subtract 2.2 ton plus the mass of all attached hook, slings etc. to the boom from the each lifting capacity of the boom, with an upper limit of 14 ton.
Do not use the rooster sheave in this situation. And do not operate the boom while the jib is rigged, when the outriggers are retracted.
- In whatever working conditions the corresponding minimum boom angle is shown in the chart.
The crane can tip over if the boom is lowered below the minimum boom angle even if unloaded.
Therefore, never lower the boom below these angles.
- The standard parts of line for each boom length are as indicated in the chart. If you work with a non-standard number of parts of line, do not exceed 37.2kN (3.8tf) per wire rope respectively.
- Crane operation is permissible up to a wind speed of 10m/s. Even in relatively light wind conditions, extra care should be taken when handling loads presenting large wind catching areas.
- Kato bears no liability whatsoever for damage, crane tipping or other accident caused by crane operations which differ from the directions contained in the instruction manual and the warning labels.

When the outriggers are not used

- The lifting capacity charts are based on the jib stowed on the boom side.
- The lifting capacity chart indicates the maximum load the crane can lift when its body is level on firm level ground with all tires inflated to the rated pressure and the suspension cylinder completely retracted. The values in the chart include the mass of the main hook and slings.
Within the chart the figures in the area bordered with a thick line are based on structural limitations while other figures are determined by stability limitations.
[Rated tire pressure:900kPa (9.0bar)]
- The working radii are the actual values allowing for boom deflection. Therefore you must always operate the crane on the basis of the working radius.
- The lifting capacity differs between the front area capacity and the full range capacity.
When slewing from the front to the side, take care that the crane could not be over loaded.

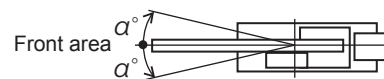

Crane operation	Stationary crane-on-rubber operation	Pick and carry operation
Area α°	1	1

- The lifting capacity of the rooster sheave is the lifting capacity of the boom minus the mass of all attached hook, slings etc. to the boom, with an upper limit of 4,000kg.
[The hook for use with the rooster sheave is the 4 ton hook(mass:80kg) with one part of line.]
- Do not work with the jib or with a boom length of more than 23.45m.
- For stationary crane-on-rubber operation, the parking brake and service brake lock device must be engaged.
- For pick and carry operation, the super-slow speed switch must be switched to "ON" and the shift lever set to speed 1.
- For pick and carry operation, lower the load to just above the ground and keep your speed strictly below 2km/h to avoid swinging the load.
Take particular care to avoid sharp turns, sudden starts and stops.
- Never operate the crane during pick and carry operation. The slewing brake must be applied.
- If the boom length, boom angle and/or working radius exceeds the rated value, use the lifting capacity for the rated value or for the next one, whichever gives the smaller lifting capacity.
- In whatever working conditions the corresponding minimum boom angle is shown in the chart.
The crane can tip over if the boom is lowered below the minimum boom angle even if unloaded.
Therefore, never lower the boom below these angles.
- The standard parts of line for each boom length are as indicated in the chart. If you work with a non-standard number of parts of line, do not exceed 37.2kN (3.8tf) per wire rope respectively.
- Crane operation is permissible up to a wind speed of 10m/s. Even in relatively light wind conditions, extra care should be taken when handling loads presenting large wind catching areas.
- Kato bears no liability whatsoever for damage, crane tipping or other accident caused by crane operations which differ from the directions contained in the instruction manual and the warning labels.

WORKING RANGE

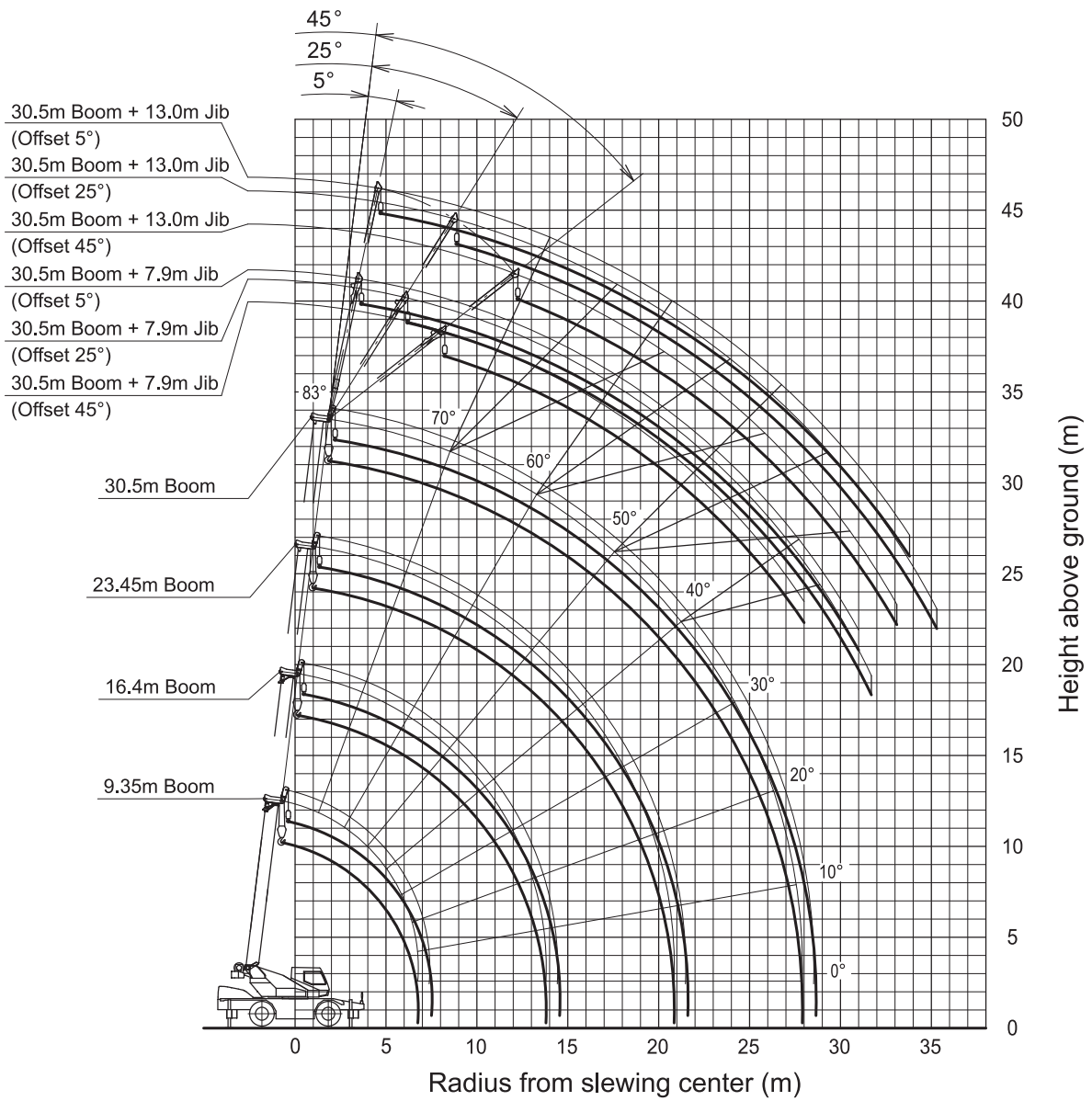

Notes:

1. This diagram does not include deflection of Boom and Fly jib.
2. The outriggers are fully extended.

LIFTING CAPACITY

Based on ISO 4305
Not exceed 75% of static tipping loads

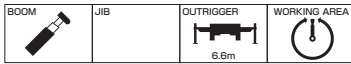

[m]		9.35	16.4	23.45	30.5
	2.5	30.00*	19.00	12.50	
	3.0	30.00*	19.00	12.50	
	3.5	27.20*	19.00	12.50	7.50
	4.0	23.00	19.00	12.50	7.50
	4.5	21.20	18.65	12.50	7.50
	5.0	19.40	17.30	12.50	7.50
	5.5	17.80	16.15	12.50	7.50
	6.0	16.30	15.15	12.25	7.50
	6.5	15.10	14.25	11.50	7.50
	7.0		13.45	10.80	7.50
	7.5		12.70	10.20	7.50
	8.0		11.80	9.65	7.50
	9.0		9.70	8.65	6.80
	10.0		7.90	7.85	6.15
	11.0		6.50	6.90	5.60
	12.0		5.45	6.00	5.10
	13.0		4.55	5.20	4.70
	13.5		4.20	4.85	4.50
	14.0			4.50	4.35
	15.0			3.90	4.05
	16.0			3.45	3.75
	17.0			3.00	3.35
	18.0			2.65	2.95
	19.0			2.35	2.65
	20.0			2.05	2.35
	20.5			1.95	2.25
	21.0				2.10
22.0				1.90	
24.0				1.50	
26.0				1.20	
27.9				0.95	
	BOOM 2 [%]	0	100	100	100
	BOOM 3 [%]	0	0	50	100
	BOOM 4 [%]	0	0	50	100
	MIN	[°]	—	—	—
	CAPACITY	[ton]	30		
	MASS	[kg]	250		
	[Parts of line]	9*/7	6	4	4

(Unit : Metric ton)

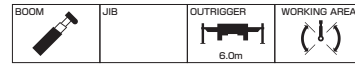

[m]		9.35	16.4	23.45	30.5
	2.5	30.00*	19.00	12.50	
	3.0	30.00*	19.00	12.50	
	3.5	27.20*	19.00	12.50	7.50
	4.0	23.00	19.00	12.50	7.50
	4.5	21.20	18.65	12.50	7.50
	5.0	19.40	17.30	12.50	7.50
	5.5	17.80	16.15	12.50	7.50
	6.0	16.30	15.15	12.25	7.50
	6.5	15.10	13.50	11.50	7.50
	7.0		12.00	10.80	7.50
	7.5		10.75	10.20	7.50
	8.0		9.65	9.35	7.50
	9.0		7.95	7.85	6.80
	10.0		6.50	6.70	6.15
	11.0		5.35	5.75	5.60
	12.0		4.50	5.00	5.05
	13.0		3.75	4.35	4.50
	13.5		3.45	4.05	4.20
	14.0			3.75	4.00
	15.0			3.25	3.55
	16.0			2.85	3.20
	17.0			2.50	2.85
	18.0			2.15	2.50
	19.0			1.90	2.20
	20.0			1.65	2.00
	20.5			1.55	1.85
	21.0				1.75
22.0				1.55	
24.0				1.20	
26.0				0.95	
27.9				0.70	
	BOOM 2 [%]	0	100	100	100
	BOOM 3 [%]	0	0	50	100
	BOOM 4 [%]	0	0	50	100
	MIN	[°]	—	—	—
	CAPACITY	[ton]	30		
	MASS	[kg]	250		
	[Parts of line]	9*/7	6	4	4

(Unit : Metric ton)

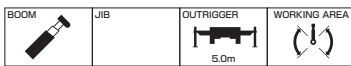

[m]		9.35	16.4	23.45	30.5
	2.5	30.00*	19.00	12.50	
	3.0	30.00*	19.00	12.50	
	3.5	27.20*	19.00	12.50	7.50
	4.0	23.00	19.00	12.50	7.50
	4.5	21.20	17.30	12.50	7.50
	5.0	18.85	14.70	12.50	7.50
	5.5	15.65	12.65	11.80	7.50
	6.0	13.15	11.05	10.45	7.50
	6.5	11.25	9.75	9.35	7.50
	7.0		8.70	8.40	7.50
	7.5		7.75	7.60	7.40
	8.0		7.00	6.95	6.80
	9.0		5.75	5.80	5.75
	10.0		4.70	4.90	4.95
	11.0		3.85	4.20	4.30
	12.0		3.15	3.60	3.75
	13.0		2.60	3.10	3.30
	13.5		2.40	2.90	3.05
	14.0			2.70	2.90
	15.0			2.30	2.55
	16.0			2.00	2.25
	17.0			1.70	1.95
	18.0			1.45	1.75
	19.0			1.20	1.55
	20.0			1.05	1.35
	20.5			0.95	1.25
	21.0				1.15
22.0				1.00	
24.0				0.70	
26.0				0.50	
	BOOM 2 [%]	0	100	100	100
	BOOM 3 [%]	0	0	50	100
	BOOM 4 [%]	0	0	50	100
	MIN	[°]	—	—	20
	CAPACITY	[ton]	30		
	MASS	[kg]	250		
	[Parts of line]	9*/7	6	4	4

(Unit : Metric ton)

Based on ISO 4305
Not exceed 75% of static tipping loads

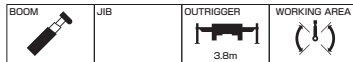

[m]	9.35	16.4	23.45	30.5
2.5	30.00*	19.00	12.50	
3.0	26.00	18.90	12.50	
3.5	20.20	15.20	12.50	7.50
4.0	16.35	12.60	11.40	7.50
4.5	13.65	10.65	9.85	7.50
5.0	11.40	9.10	8.60	7.50
5.5	9.50	7.90	7.55	7.25
6.0	8.10	6.90	6.70	6.50
6.5	7.05	6.05	6.00	5.85
7.0		5.35	5.40	5.35
7.5		4.75	4.85	4.85
8.0		4.25	4.40	4.45
9.0		3.40	3.60	3.70
10.0		2.75	3.00	3.15
11.0		2.20	2.50	2.65
12.0		1.75	2.10	2.30
13.0		1.35	1.70	1.95
13.5		1.20	1.55	1.80
14.0			1.40	1.65
15.0			1.15	1.40
16.0			0.95	1.15
17.0			0.75	1.00
18.0			0.60	0.80
19.0				0.65
20.0				0.50
BOOM 2 [%]	0	100	100	100
BOOM 3 [%]	0	0	50	100
BOOM 4 [%]	0	0	50	100
MIN [°]	—	—	28	41
CAPACITY [ton]	30			
MASS [kg]	250			
[Parts of line]	9*7	6	4	4

(Unit : Metric ton)

[m]	9.35	16.4	23.45	30.5
2.5	12.00	10.35	9.10	
3.0	11.15	8.25	7.50	
3.5	9.00	6.75	6.30	5.50
4.0	7.45	5.60	5.35	5.15
4.5	6.25	4.65	4.60	4.50
5.0	5.30	3.95	3.95	3.95
5.5	4.50	3.30	3.45	3.45
6.0	3.85	2.80	3.00	3.05
6.5	3.30	2.35	2.60	2.70
7.0		2.00	2.25	2.40
7.5		1.65	1.95	2.15
8.0		1.40	1.70	1.90
9.0		0.90	1.25	1.50
10.0		0.55	0.90	1.15
11.0			0.60	0.85
12.0				0.65
BOOM 2 [%]	0	100	100	100
BOOM 3 [%]	0	0	50	100
BOOM 4 [%]	0	0	50	100
MIN [°]	—	40	55	62
CAPACITY [ton]	30			
MASS [kg]	250			
[Parts of line]	7	6	4	4

(Unit : Metric ton)

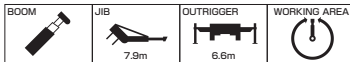

Boom [m]	30.5					
	5		25		45	
Jib [°]	5		25		45	
	[m]	[ton]	[m]	[ton]	[m]	[ton]
83.0	4.5	3.50	7.2	2.40	9.1	1.70
75.0	10.5	3.50	12.6	2.40	14.1	1.70
73.0	11.9	3.35	13.9	2.40	15.3	1.69
71.0	13.2	3.11	15.2	2.32	16.5	1.66
69.0	14.5	2.89	16.3	2.19	17.6	1.63
65.0	16.9	2.45	18.7	1.94	19.8	1.57
61.0	19.2	2.12	20.9	1.73	21.8	1.53
58.0	20.8	1.92	22.5	1.60	23.3	1.47
55.0	22.4	1.68	24.0	1.49	24.6	1.39
54.0	22.8	1.60	24.4	1.46	25.0	1.37
50.0	24.8	1.26	26.2	1.16	26.6	1.16
46.0	26.6	0.99	27.8	0.93	28.0	0.93
40.0	28.9	0.69	29.8	0.68		
34.0	31.0	0.46	31.7	0.45		
BOOM 2 [%]	100					
	100					
	100					
MIN [°]	32		32		44	
CAPACITY [ton]	4					
MASS [kg]	80					
[Parts of line]	1					









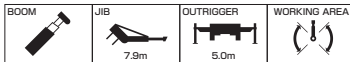



(Unit : Metric ton)



Boom [m]	30.5					
	5		25		45	
Jib [°]	5		25		45	
	[m]	[ton]	[m]	[ton]	[m]	[ton]
83.0	4.5	3.50	7.2	2.40	9.1	1.70
75.0	10.5	3.50	12.6	2.40	14.1	1.70
73.0	11.9	3.35	13.9	2.40	15.3	1.69
71.0	13.2	3.11	15.3	2.32	16.5	1.66
69.0	14.5	2.89	16.3	2.19	17.6	1.63
65.0	16.9	2.45	18.7	1.94	19.8	1.57
64.0	17.5	2.35	19.3	1.88	20.3	1.56
63.0	18.1	2.27	19.8	1.83	20.8	1.55
61.0	19.1	2.01	20.9	1.73	21.8	1.53
59.0	20.2	1.78	21.9	1.62	22.8	1.50
55.0	22.2	1.37	23.7	1.29	24.5	1.25
46.0	26.4	0.75	27.7	0.71	27.9	0.71
45.0	26.8	0.70	28.0	0.67		
40.0	28.8	0.48	29.8	0.46		
BOOM 2 [%]	100					
	100					
	100					
MIN [°]	38		38		44	
CAPACITY [ton]	4					
MASS [kg]	80					
[Parts of line]	1					













(Unit : Metric ton)



 [m]	30.5					
	5		25		45	
 [°]						
	[m]	[ton]	[m]	[ton]	[m]	[ton]
83.0	4.5	3.50	7.2	2.40	9.1	1.70
75.0	10.5	3.50	12.6	2.40	14.1	1.70
73.0	11.9	3.35	13.9	2.40	15.3	1.69
72.0	12.5	3.23	14.6	2.37	15.9	1.68
71.0	13.1	2.98	15.3	2.32	16.5	1.66
69.0	14.3	2.55	16.3	2.19	17.6	1.63
66.0	16.3	1.92	18.0	1.76	19.3	1.58
61.0	18.7	1.35	20.6	1.20	21.7	1.15
55.0	21.8	0.81	23.4	0.74	24.3	0.71
53.0	22.8	0.67	24.4	0.60	25.1	0.59
51.0	23.8	0.53	25.3	0.50	26.0	0.47
	BOOM 2 [%]	100				
	BOOM 3 [%]	100				
	BOOM 4 [%]	100				
 MIN [°]	49		49		49	
 CAPACITY [ton]	4					
 MASS [kg]	80					
 [Parts of line]	1					

(Unit : Metric ton)



 [m]	30.5					
	5		25		45	
 [°]						
	[m]	[ton]	[m]	[ton]	[m]	[ton]
83.0	4.5	3.50	7.2	2.40	9.1	1.70
78.0	8.3	3.50	10.6	2.40	12.2	1.70
76.0	9.6	3.13	11.9	2.40	13.5	1.70
73.0	11.4	2.31	13.8	1.87	15.3	1.69
71.0	12.6	1.87	14.9	1.55	16.4	1.41
67.0	14.9	1.22	17.1	1.03	18.3	0.97
61.0	18.3	0.56	20.2	0.48	21.3	0.45
	BOOM 2 [%]	100				
	BOOM 3 [%]	100				
	BOOM 4 [%]	100				
 MIN [°]	59		59		59	
 CAPACITY [ton]	4					
 MASS [kg]	80					
 [Parts of line]	1					

(Unit : Metric ton)

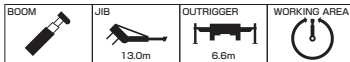

[m]	30.5					
	5		25		45	
[°]	[m]	[ton]	[m]	[ton]	[m]	[ton]
83.0	5.6	2.20	10.0	1.25	13.2	0.85
77.0	10.8	2.20	14.5	1.25	17.2	0.85
73.0	14.2	2.18	17.4	1.17	19.8	0.85
71.0	15.6	2.02	18.8	1.12	21.1	0.84
65.0	19.6	1.61	22.7	1.01	24.5	0.80
61.0	22.3	1.42	25.1	0.94	26.7	0.78
60.0	23.0	1.38	25.7	0.93	27.2	0.78
53.0	27.2	1.19	29.5	0.87	30.4	0.77
49.0	29.3	0.94	31.4	0.84	32.0	0.77
47.0	30.3	0.83	32.3	0.76	32.8	0.77
46.0	30.7	0.78	32.7	0.72	33.1	0.72
42.0	32.5	0.61	34.2	0.57		
39.0	33.8	0.49	35.3	0.47		
BOOM 2 [%]	100					
BOOM 3 [%]	100					
BOOM 4 [%]	100					
MIN [°]	37		37		44	
CAPACITY [ton]	4					
MASS [kg]	80					
[Parts of line]	1					









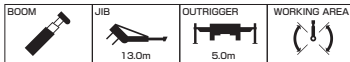





(Unit : Metric ton)



[m]	30.5					
	5		25		45	
[°]	[m]	[ton]	[m]	[ton]	[m]	[ton]
83.0	5.6	2.20	10.0	1.25	13.2	0.85
77.0	10.8	2.20	14.5	1.25	17.2	0.85
73.0	14.2	2.18	17.4	1.17	19.8	0.85
71.0	15.6	2.02	18.8	1.12	21.1	0.84
65.0	19.6	1.61	22.7	1.01	24.5	0.80
61.0	22.3	1.42	25.1	0.94	26.7	0.78
60.0	23.0	1.38	25.7	0.93	27.2	0.78
58.0	24.2	1.31	26.8	0.91	28.1	0.78
54.0	26.5	1.01	28.9	0.88	30.0	0.77
52.0	27.5	0.89	29.9	0.82	30.9	0.77
50.0	28.5	0.78	30.8	0.72	31.7	0.70
46.0	30.6	0.58	32.5	0.55	33.0	0.55
44.0	31.4	0.51	33.3	0.47		
BOOM 2 [%]	100					
BOOM 3 [%]	100					
BOOM 4 [%]	100					
MIN [°]	42		42		44	
CAPACITY [ton]	4					
MASS [kg]	80					
[Parts of line]	1					















(Unit : Metric ton)



 [m]	30.5					
 [°]	5		25		45	
 [°]						
	[m]	[ton]	[m]	[ton]	[m]	[ton]
83.0	5.6	2.20	10.0	1.25	13.2	0.85
77.0	10.8	2.20	14.5	1.25	17.2	0.85
73.0	14.2	2.18	17.4	1.17	19.8	0.85
71.0	15.6	2.02	18.8	1.12	21.1	0.84
68.0	17.6	1.79	20.7	1.07	22.8	0.82
62.0	21.4	1.15	24.5	0.96	26.1	0.79
60.0	22.5	0.97	25.5	0.84	27.2	0.78
58.0	23.7	0.82	26.6	0.71	28.1	0.68
54.0	26.0	0.55	28.6	0.49	29.8	0.48
	BOOM 2 [%]	100				
	BOOM 3 [%]	100				
	BOOM 4 [%]	100				
 MIN [°]	52		52		52	
 CAPACITY [ton]	4					
 MASS [kg]	80					
 [Parts of line]	1					

(Unit : Metric ton)



 [m]	30.5					
 [°]	5		25		45	
 [°]						
	[m]	[ton]	[m]	[ton]	[m]	[ton]
83.0	5.6	2.20	10.0	1.25	13.2	0.85
77.0	10.8	2.20	14.5	1.25	17.2	0.85
76.0	11.6	2.20	15.2	1.24	17.8	0.85
71.0	15.0	1.47	18.8	1.12	21.1	0.84
69.0	16.4	1.17	20.0	0.93	22.2	0.82
67.0	17.7	0.93	21.1	0.75	23.3	0.68
64.0	19.6	0.64	22.9	0.51	24.8	0.47
	BOOM 2 [%]	100				
	BOOM 3 [%]	100				
	BOOM 4 [%]	100				
 MIN [°]	62		62		62	
 CAPACITY [ton]	4					
 MASS [kg]	80					
 [Parts of line]	1					

(Unit : Metric ton)

■ When outriggers are not used



[m]		9.35		16.4		23.45	
WORKING AREA							
	3.0	13.50	8.10	9.00	6.80		
	3.5	12.00	6.80	9.00	5.60	6.50	4.50
	4.0	10.75	5.80	9.00	4.65	6.50	4.45
	4.5	9.65	5.00	9.00	3.85	6.50	3.80
	5.0	8.70	4.30	8.20	3.20	6.50	3.25
	5.5	7.80	3.60	7.40	2.70	6.05	2.80
	6.0	7.00	3.00	6.60	2.25	5.65	2.45
	6.5	6.25	2.50	5.90	1.85	5.25	2.10
	7.0			5.20	1.55	4.85	1.80
	8.0			4.00	1.00	4.10	1.30
	9.0			3.15	0.60	3.50	0.95
	10.0			2.50		3.00	0.60
	11.0			2.00		2.50	
	12.0			1.60		2.10	
	13.0			1.25		1.75	
	14.0					1.45	
	15.0					1.20	
	16.0					0.95	
17.0					0.75		
18.0					0.55		
	BOOM 2 [%]	0		100		100	
	BOOM 3 [%]	0		0		50	
	BOOM 4 [%]	0		0		50	
	MIN [°]	—	—	—	45	29	59
	CAPACITY [ton]	30					
	MASS [kg]	250					
	[Parts of line]	4					

(Unit : Metric ton)

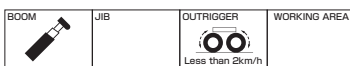

[m]		9.35		16.4		23.45	
WORKING AREA							
	3.0	10.00	6.10	6.60	5.10		
	3.5	8.95	5.10	6.60	4.90	5.50	3.20
	4.0	8.00	4.30	6.60	4.10	5.50	3.20
	4.5	7.10	3.65	6.60	3.45	5.50	3.20
	5.0	6.40	3.15	6.00	2.90	5.50	2.95
	5.5	5.75	2.65	5.40	2.40	5.15	2.55
	6.0	5.20	2.25	5.00	1.95	4.80	2.20
	6.5	4.70	1.90	4.45	1.60	4.45	1.90
	7.0			3.90	1.30	4.15	1.60
	8.0			3.00	0.80	3.45	1.15
	9.0			2.40		2.80	0.80
	10.0			1.80		2.30	0.50
	11.0			1.30		1.90	
	12.0			1.00		1.55	
	13.0			0.75		1.25	
	14.0					1.00	
	15.0					0.75	
	16.0					0.55	
	BOOM 2 [%]	0		100		100	
	BOOM 3 [%]	0		0		50	
	BOOM 4 [%]	0		0		50	
	MIN [°]	—	—	—	51	38	58
	CAPACITY [ton]	30					
	MASS [kg]	250					
	[Parts of line]	4					

(Unit : Metric ton)

Minimum path width

Left turn in two-wheel steering mode

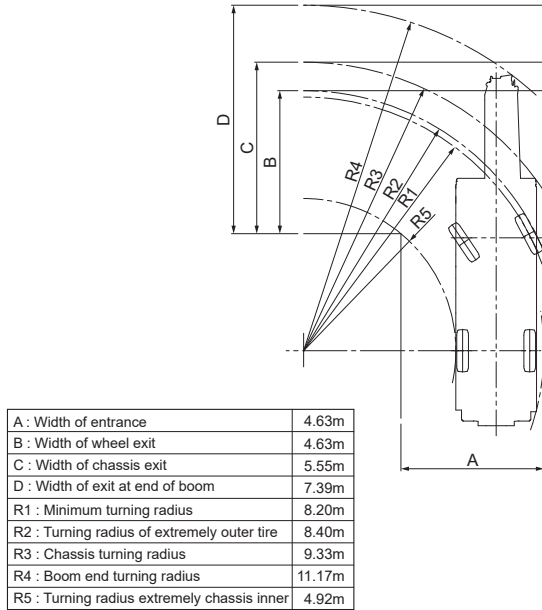

Left turn in 4-wheel steering mode

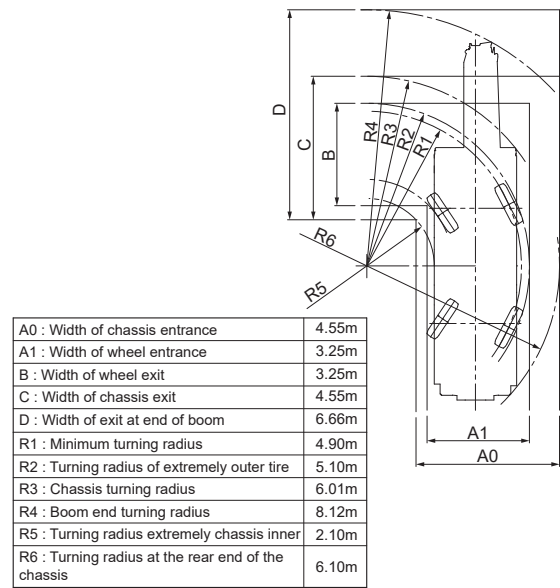

Note: The above values are based on calculations.
The special steering is only available for driving within the work site.

Overall view

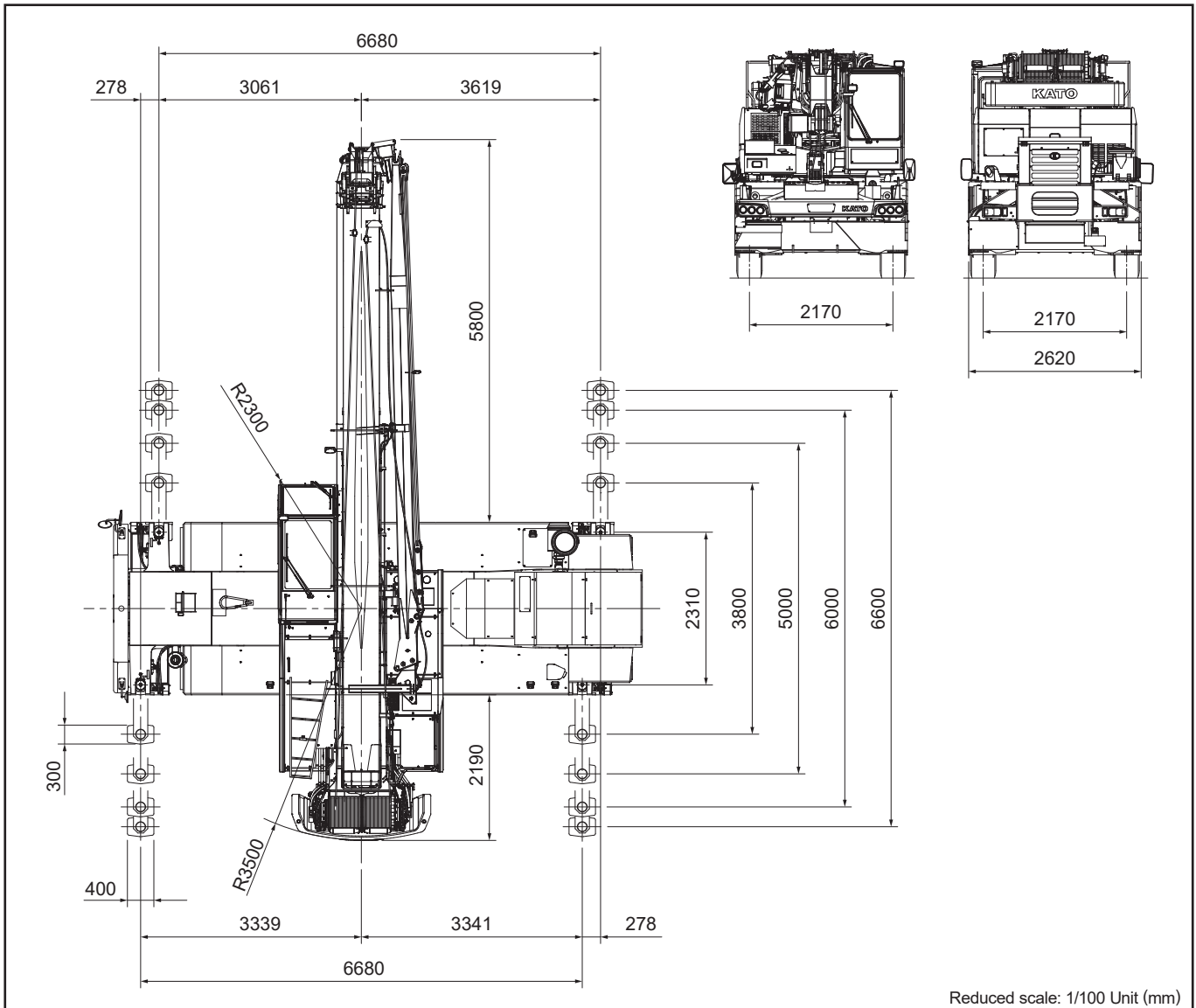

Overall view

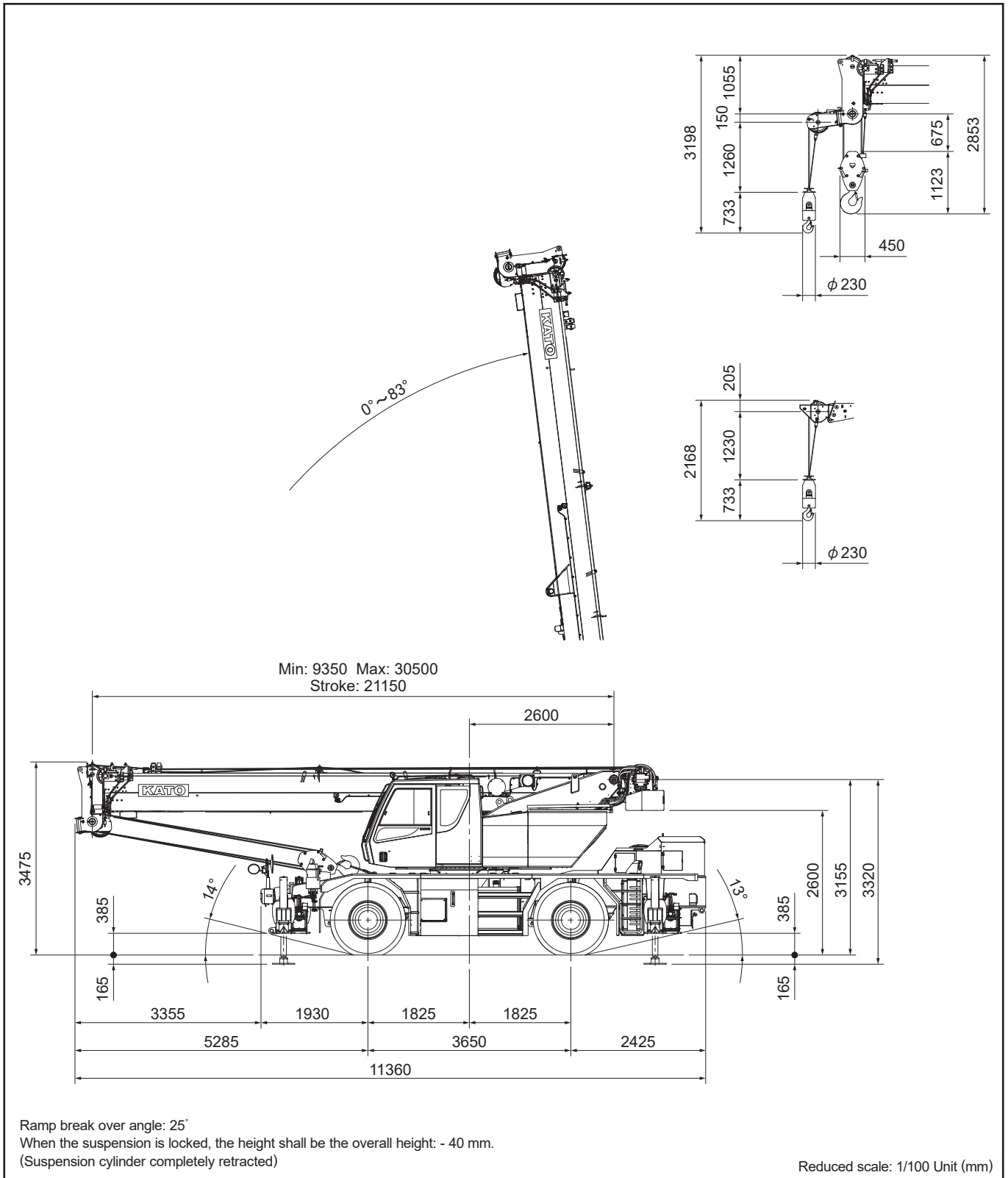

* KATO products and specifications are subject to improvements and changes without notice.

Address inquiries to:

KATO

KATO WORKS CO.,LTD.

9-37, Higashi-ohi 1-chome, Shinagawa-ku, Tokyo, 140-0011, Japan

Tel. : Head Office Tokyo +81 (0)3 3458-1111
Overseas Marketing Department. Tokyo +81 (0)3 3458-1115

Fax. : Tokyo +81 (0)3 3458-1152

URL <http://www.kato-works.co.jp>

C05391

6.2020-1000 (TI) 1