

目次

主要諸元	2
仕様一覧表	3
定格総荷重表注意事項	4
定格総荷重表	
ブーム【MODE A(通常伸縮)・MODE B(特殊伸縮)】	6
ブーム+SLジブ	11
ブーム【定置つり】【走行つり】	35
作業範囲図	36
最小通路軌跡図	37
全体図	38
全体図	39

■主要諸元

■クレーン部

名 称	35t吊りラフテレーンクレーン
型 式	KRM-35H-F

●クレーン性能

最大定格総荷重	7.5 mブーム	35,000kg×2.6m (10本掛)
	12.5 mブーム	19,000kg×5.5m (6本掛)
	17.5 mブーム	17,000kg×5.0m (6本掛)
	22.5 mブーム	12,000kg×6.5m (4本掛)
	27.5 mブーム	9,000kg×7.0m (4本掛)
	32.5 mブーム	7,000kg×8.0m (4本掛)
	6.5 mジブ	3,200kg×76° (1本掛)
	10.25 mジブ	2,000kg×71° (1本掛)
	14.0 mジブ	1,350kg×76° (1本掛)
	ルースタシブ	4,500kg (1本掛)

ブーム長さ	7.5m ~ 32.5m
-------	--------------

ジブ長さ	6.5m ~ 14.0m
------	--------------

最大地上揚程	33.9m (ブーム)
--------	-------------

最大地上揚程	47.9m (ジブ)
--------	------------

巻上ロープ速度	主巻	125m/min (4層目)
	補巻	125m/min (4層目)

巻上フック速度	主	(ロープ掛数 10) 12.5m / min (4層目)
	補	(ロープ掛数 1) 125.0m / min (4層目)

高速巻下(主・補)	163m / min (4層目)無負荷参考値
-----------	------------------------

ブーム起伏範囲	-10° ~ 84°
---------	------------

ブーム上げ時間	44s / -10° ~ 84°
---------	------------------

ブーム伸長速度	25.0m / 85s
---------	-------------

旋回速度	2.5min ⁻¹
------	----------------------

旋回後端半径	2,850mm
--------	---------

●上部旋回体の装置および構造

ブーム形式	箱型6段油圧伸縮式 (2・3段同時、4・5・6段同時)
-------	-----------------------------

ジブ形式	3段油圧伸縮式 (2・3段同時) 油圧無段傾斜式 (オフセット5° (6.5mジブは7°) ~ 60°)
------	---

ブーム伸縮装置	油圧シリンダ (2本) およびワイヤロープ併用式
---------	--------------------------

ブーム起伏装置	油圧シリンダ直押し式、圧力補償付流量調整弁付
---------	------------------------

ジブ伸縮装置	油圧シリンダ (1本) およびワイヤロープ併用式
--------	--------------------------

ジブ起伏装置	油圧シリンダ (2本)
--------	-------------

巻上装置	シングルウィンチ2基、 油圧モータ駆動・遊星歯車減速機付 (ネガティブブレーキ内蔵)、 高低速切換式、自動ブレーキ付、圧力補償付流量調整弁付
------	--

旋回装置	油圧モータ駆動・遊星歯車減速機付 (ネガティブブレーキ内蔵)、フリー・ロック切換式
------	---

旋回サークル	ボールベアリング式
--------	-----------

アウトリガ装置	形式	全油圧H型 (フロート、パーチカルシリンダ一体型)
	張出幅	6,800mm (最大張出)
		6,300mm (中間張出)
		5,200mm (中間張出)
		4,200mm (中間張出)
2,310mm (最縮小張出)		

ワイヤロープ	主巻	難自転性ワイヤロープ φ16×181m
	補巻	難自転性ワイヤロープ φ16×102m

●油圧装置

油圧ポンプ	2連可変プランジャ型、ギヤ + 可変プランジャ型
-------	--------------------------

油圧モータ	巻上用	アキシャルプランジャ型
	旋回用	アキシャルプランジャ型

コントロールバルブ	マルチプル自動復元式 (圧力補償付流量調整弁付)
-----------	--------------------------

シリンダ	ダブルアクティング式
------	------------

オイルリザーバ容量	500L
-----------	------

●安全装置

安全装置	過負荷防止装置 (ACS・音声警報装置付)、旋回自動停止装置、ブーム起伏緩停止装置、 ブーム伸長緩停止装置、過巻防止装置、作業範囲制限装置、アウトリガ張出幅自動検出装置、 電子水準器 (アウトリガ水平補助機能付)、油圧安全弁、ブーム起伏自然降下防止装置、 ブーム伸縮自然降下防止装置、ジブ起伏自然降下防止装置、ジブ伸縮自然降下防止装置、 ウィンチ自然降下防止装置、ウィンチブレーキ装置、旋回ブレーキ装置、 アウトリガロック装置、旋回ロック装置、玉掛ロープはずれ止め
------	---

●標準装置

標準装置	オイルクーラ、作動油オーバーヒート警報装置、作動油フィルタ目つまり警報装置、 LED旋回警告灯、乱巻防止装置、ドラム回転指示装置、ACS外部表示装置、 拡声器、ウィンチ確認カメラ、LED作業灯 (ブーム、テーブル、キャブ)、 クレーン作業記録装置、アルミ敷板、木製敷板
------	---

●キャブ装備

キャブ装備	オートエアコン、ラバーマウント式キャブ フルアジャスタブル・サスペンションシート (ヘッドレスト、アームレスト付)、 パワーウィンドウ (閉め忘れ防止スイッチ付)、 間欠付フロント&ルーフワイパー (ウォッシャー付)、ルームランプ、 ステップランプ、アクセサリソケット (24V)、USB電源装置
-------	--

■キャリア部

●走行性能

最高速度	49km / h
------	----------

登坂能力	0.55 (tanθ)
------	-------------

最小回転半径	8.1m (2輪操向)
	4.9m (4輪操向)

●エンジン

名 称	カミンズQSB6.7-4E (コモンレール式電子制御) (平成26年ディーゼル特殊自動車排出ガス規制適合)
-----	--

形 式	水冷4サイクル直列6気筒 直接噴射式ディーゼルエンジン
-----	-----------------------------

総排気量	6.690L
------	--------

最高出力	209kW / 2,000 min ⁻¹
------	---------------------------------

最大トルク	1152N・m / 1,500 min ⁻¹
-------	-----------------------------------

●下部走行体の装置および構造

走行駆動形式	2輪駆動 (4×2)、4輪駆動 (4×4) 切換式
--------	---------------------------

トルクコンバータ形式	3要素 1段 (自動ロックアップラッチ付)
------------	-----------------------

変速機形式	全自動および手動変速式
-------	-------------

変速段数	前進4段 後退1段 (Hi/Low切換)
------	----------------------

車軸形式	前軸	全浮動式 2段減速機付
	後軸	全浮動式 2段減速機付

懸架装置	前軸	テーパーフスプリング式 (油圧ロックシリンダ付)
	後軸	テーパーフスプリング式 (油圧ロックシリンダ付)

ブレーキ装置	主 2系統空気油圧複合式 4輪ディスクブレーキ
--------	-------------------------

ステアリング装置	形式	全油圧式パワーステアリング
	モード	前2輪、カウンタ、クラフ、後2輪、前後輪独立 (5モード) (リヤステ自動ロック機構付)

タイヤサイズ	前輪 385 / 95 R25 170E ROAD
--------	---------------------------

燃料タンク容量	300L
---------	------

尿素水タンク容量	33L
----------	-----

バッテリー	(12V-120Ah) × 2
-------	-----------------

●安全装置

安全装置	緊急用かじり取装置、後輪ステアリングロック装置、ブレーキ液漏警報装置、 作業用補助制動装置、坂道発進補助装置、サスペンションロック装置、 オーバールン警報装置、ラジエータ液面警報装置、 エアフィルタ目つまり警報装置、ローエアー警報装置、前方確認カメラ
------	--

●標準装備

標準装備	チルト/テレスコピックハンドル、エントリーキーステム、LEDヘッドランプ、 路肩灯、集中給脂装置、車輪止め、デジタルタコグラフ
------	--

■寸法・重量

全長	9,800mm
----	---------

全幅	2,620mm
----	---------

全高	3,595mm
----	---------

軸距	3,650mm
----	---------

輪距	前輪	2,170mm
	後輪	2,170mm

乗車定員	1人
------	----

車両総重量	全重量	27,925kg
	前軸重	13,970kg
	後軸重	13,955kg

●本機は、新規開発車両証明制度による適合証明書「基本通行条件 重量：D」の交付を受けていますが、実際の通行条件は、運行経路ごとの道路管理者の算定結果によって付与されます。

■運転および作業に必要な資格

注意事項	クレーンの運転	移動式クレーン運転免許
------	---------	-------------

注意事項	玉掛作業	玉掛技能講習
------	------	--------

注意事項	車両の運転	大型特殊自動車運転免許
------	-------	-------------

注意事項	クレーンの運転	移動式クレーン運転免許
------	---------	-------------

注意事項	玉掛作業	玉掛技能講習
------	------	--------

注意事項	車両の運転	大型特殊自動車運転免許
------	-------	-------------

●クレーンに関しては、労働安全衛生法が適用されます。

●所轄の労働基準監督署に設置報告してからお使いください。

●道路を通行する場合は、車両検査に合格した状態で通行してください。

●走行時はフックを所定の位置に格納してください。

●本車両は最低速度 (50km/h) の定めのある「高速自動車国道」を走行することはできません。

●本機の使用にあたっての注意事項は、取扱説明書をよく読んで正しくお使いください。

●本カタログに記載されておりませんが性能ならびに仕様は、改良などによりお届けいたします製品と異なる場合があります。また、仕様は予告なく変更することがありますのであらかじめご了承ください。

MR-350RfII

仕様一覧表

仕様A：クリアランスソナーシステム無し、セーフティビューシステム無し
 仕様B：クリアランスソナーシステム有り、セーフティビューシステム無し
 仕様C：クリアランスソナーシステム有り、セーフティビューシステム有り

◎：標準設定 ●：オプション -：設定不可

	仕様A	仕様B	仕様C
クリアランスソナーシステム (左前部、左前輪部、左後角部、右後角部および最後部検出)	-	◎	◎
7インチモニタ	◎	◎	-
後方確認カメラ(上物)	◎	◎	-
左前方確認カメラ	◎	◎	-
無線式後方確認カメラ	●	●	-
セーフティビューシステム ※1 人検知アシスト(カメラ3か所：左前方、左後方、右後方) 12.1インチタッチモニタ サラウンドビュー(カメラ4か所：前方、後方、左方、右方) ※1 PDF表示機能	-	-	◎
ACS外部音声警報装置	-	●	◎
ブーム右側ミラー(ヒータ付き)	●	●	◎
風速計	●	●	◎
電動格納サイドミラー ※2	◎	◎	-
ヒータ&電動調整式電動格納サイドミラー ※2	●	●	◎
サイドマーカーランプ ※3	◎	◎	-
LEDサイドマーカーランプ(アンダーライト付き) ※3	-	●	◎
AM/FMラジオ	◎	-	-
Bluetooth付AM/FMラジオ	-	◎	◎
スタンション	●	●	●
燃焼式エアヒータ	●	●	●
タイヤ空気圧モニタリングシステム	-	●	●
アウトリガ操作ラジコン ※4	-	●	●
エンジン非常停止スイッチ(キャリヤ) ※4	-	●	●
ランチテーブル	●	●	◎
ハンズフリーマイク	-	●	◎
左折およびバック音声警報装置	-	●	◎
ドアバイザ	●	●	●
マッドガード	●	●	●
フロアマット	●	◎	◎
消火器	●	●	●
アッシュトレイ	●	●	●

※1 セーフティビューシステムは人検知アシスト、12.1インチタッチモニタ、サラウンドビュー、PDF表示機能を一括りにまとめている。(個別のOPT設定不可)

※2 電動格納サイドミラーとヒータ&電動調整式電動格納サイドミラーの同時装着は不可。

※3 サイドマーカーランプとLEDサイドマーカーランプ(アンダーライト付き)の同時装着は不可。

※4 アウトリガ操作ラジコンとエンジン非常停止スイッチ(キャリヤ)は同時装着となる。(個別設定不可)

●Bluetooth®はBluetooth SIG, Incの登録商標です。

定格総荷重表注意事項

●アウトリガ使用時

1. 定格総荷重表は水平堅土上において機体を水平に設置した状態での保証できる最大荷重を示しており、ブーム作業時は主フックとつり具、ジブ作業時は補フックとつり具の質量を含んだ値です。
【35tフック(質量310kg)、22tフック(質量225kg)、4.5tフック(質量70kg)】
□部分は機械の強度によって、他は機体の安定度によって定められています。
2. 作業半径はブーム、ジブのたわみを含んだ実際の値にもとづいていますので、必ず作業半径を基準として作業を行ってください。
3. ジブの作業半径は17.5mまたは32.5mブームにジブを装着して作業を行った場合の値です。
17.5mをこえ32.5m未満のブーム長さでのジブ作業は、作業半径ではなく32.5mブームの角度を基準としてください。また、17.5m未満のブーム長さでのジブ作業は、作業半径ではなく17.5mブームの角度を基準としてください。
4. アウトリガ最縮小張出では、ジブ作業を行わないでください。
5. アウトリガ張出状態によって側方領域でのつり上性能は異なります。従って各々の張出状態における定格総荷重表で作業を行ってください。また、前方、後方領域でのつり上性能はアウトリガ最大張出の定格総荷重表でそれぞれ作業を行ってください。

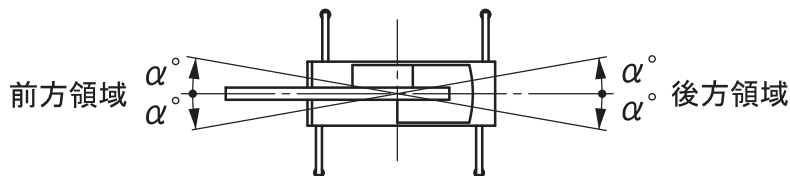

アウトリガ張出状態	中間張出(6.3m)	中間張出(5.2m)	中間張出(4.2m)	最縮小張出
領域 α°	30	30	15	3

6. ルースタシーブの定格総荷重は、ブームの定格総荷重よりブームに取付けられているフックその他のつり具の質量を差し引いた値とし、かつ限度を4,500kgとします。
【ルースタシーブ使用フック:4.5tフック(質量70kg)巻掛本数1】
7. ブーム長さ、ブーム角度、作業半径、ジブ長さ、およびジブ角度が規定の値をこえる場合にはその規定の値と、次の規定の値の定格総荷重のうち小さい方の定格総荷重を目安として作業を行ってください。
8. ジブを装着したままでブーム作業を行う場合の定格総荷重は、ブームの定格総荷重よりフックその他のつり具等の質量の他に3,300kgを差し引いた値とします。なおジブを装着したままでのルースタ作業、およびアウトリガ最縮小張出におけるジブを装着したままでのブーム作業は行わないでください。
【ジブ装着時使用主フック:22tフック(質量225kg)】
9. 各々の作業状態におけるブーム危険角度は表のとおりです。ブームを危険角度以下にしますと無負荷でも転倒しますので充分注意してください。
10. 各ブーム長さに対する標準フック巻掛本数は表のとおりです。ただし標準巻掛本数以外の掛数で使用する場合は、ワイヤロープ1本当たり37.2kN(3.8tf)を限度としてください。
11. フック巻掛本数10本(定格総荷重表*印)で作業を行う場合はルースタシーブを使用してください。
12. 高速巻下作業は、フックのみを降下するときに使用してください。また急激なレバー操作はさけてください。
13. クレーン作業は風速10m/sまで可能ですが、比較的弱い風の場合でも受風面積の大きい荷重を取扱う場合は特別な注意を払ってください。
14. 定格総荷重をこえる作業を行った場合、および正しい使い方を行わなかった場合は転倒または破損します。この場合本機の保証はいたしません。

●アウトリガ不使用時

1. 定格総荷重表は、水平堅土上においてタイヤの空気圧が規定圧で、かつサスペンションシリンダを最縮小した場合に本機の保証できる最大荷重を示しており、主フックとつり具の質量を含んだ値です。

□部分は機械の強度によって、他は機体の安定度によって定められています。

【タイヤ規定空気圧：900kPa】



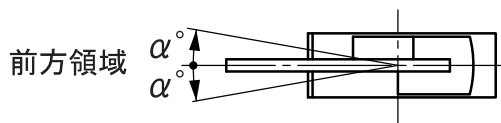



2. 作業半径はブームのたわみを含んだ実際の値にもとづいていますので、必ず作業半径を基準として作業を行ってください。
3. 前方性能と全周性能とは定格総荷重が異なります。前方領域から側方領域へ旋回する場合には、過荷重になるおそれがありますので充分注意してください。





クレーン作業領域 α°	定置つり	走行つり
	1	1







4. ルースタシーブの定格総荷重は、ブームの定格総荷重よりブームに取り付けられているフックその他のつり具の質量を差し引いた値とし、かつ限度を4,500kgとします。
【ルースタシーブ使用フック:4.5tフック(質量70kg)巻掛本数1】
5. ブーム長さ22.5mをこえるブーム作業、ジブ作業、高速巻下作業は行わないでください。
6. 定置つり作業はパーキングブレーキを効かせ、同時にブレーキロックを掛けた状態で行ってください。
7. 走行つりはハイ・ロー切換スイッチを“ON”（ローレンジ）、シフトセレクタを1速にして行ってください。
8. 走行つりは荷が振れないように地面近くに保持し、2km/h 未満にて行ってください。
特にコーナリング、急発進、急制動に注意してください。
9. 走行つり中にはクレーン作業は行わないでください。また、旋回ブレーキを必ず掛けてください。
10. ブーム長さおよび作業半径が規定の値をこえる場合にはその規定の値と、次の規定の値の定格総荷重のうち小さい方の定格総荷重を目安として作業を行ってください。
11. 各々の作業状態における危険角度は表のとおりです。ブームを危険角度以下にしますと無負荷でも転倒しますので充分注意してください。
12. 各ブーム長さに対する標準フック巻掛本数は表のとおりです。
ただし標準巻掛本数以外の掛数で使用する場合は、ワイヤロープ1本当たり37.2kN(3.8tf)を限度としてください。
13. クレーン作業は風速10m/sまで可能ですが、比較的弱い風の場合でも受風面積の大きい荷重を取扱う場合は特別な注意を払ってください。
14. 定格総荷重をこえる作業を行った場合、および正しい使い方を行わなかった場合は転倒または破損します。
この場合本機の保証はいたしません。

ブーム 	ジブ	アウトリガ  6.8m	作業範囲 
--	----	--	---



 [m]	7.5	12.5		17.5		22.5		27.5		32.5	
 [m]	2.6	35.00*	19.00	12.00	17.00	9.00	12.00	7.00			
	3.0	32.00*	19.00	12.00	17.00	9.00	12.00	7.00			
	3.5	28.80	19.00	12.00	17.00	9.00	12.00	7.00	9.00	7.00	
	4.0	26.00	19.00	12.00	17.00	9.00	12.00	7.00	9.00	7.00	
	4.5	23.00	19.00	12.00	17.00	9.00	12.00	7.00	9.00	7.00	7.00
	5.0	21.00	19.00	11.65	17.00	8.55	12.00	7.00	9.00	7.00	7.00
	5.5		19.00	10.95	15.85	8.00	12.00	6.90	9.00	7.00	7.00
	6.0		17.50	10.40	14.80	7.50	12.00	6.45	9.00	7.00	7.00
	6.5		16.00	9.85	13.80	7.05	12.00	6.05	9.00	7.00	7.00
	7.0		14.90	9.40	12.95	6.70	11.50	5.70	9.00	6.80	7.00
	8.0		12.15	8.60	11.50	6.00	10.30	5.10	8.60	6.10	7.00
	9.0		9.60	7.95	9.45	5.45	9.30	4.60	7.80	5.55	6.45
	10.0		7.70	7.50	7.60	5.00	8.35	4.15	7.10	5.05	5.90
	11.0				6.20	4.60	6.90	3.75	6.55	4.65	5.45
	12.0				5.15	4.25	5.80	3.40	6.00	4.25	5.00
	13.0				4.35	3.95	4.95	3.10	5.35	3.90	4.65
	14.0				3.65	3.65	4.25	2.85	4.65	3.60	4.30
	15.0				3.05	3.35	3.65	2.65	4.05	3.30	4.00
	16.0						3.15	2.45	3.50	3.05	3.75
	17.0						2.70	2.25	3.10	2.85	3.30
	18.0						2.35	2.10	2.70	2.70	2.95
19.0						2.00	2.00	2.35	2.50	2.60	
20.0						1.70	1.85	2.05	2.35	2.30	
22.0								1.55	2.10	1.80	
24.0								1.15	1.65	1.40	
26.0										1.10	
28.0										0.80	
30.0										0.55	
	ブーム2(%)	0	50	0	100	0	100	0	100	50	100
	ブーム3(%)	0	50	0	100	0	100	0	100	50	100
	ブーム4(%)	0	0	33	0	66	33	100	66	100	100
	ブーム5(%)	0	0	33	0	66	33	100	66	100	100
	ブーム6(%)	0	0	33	0	66	33	100	66	100	100
	MODE	A,B	A	B	A	B	A	B	A	B	A,B
 危険角度	[°]	—	—	—	—	—	—	—	—	—	—
 標準フック	[ton]	35	22								
 フック質量	[kg]	310	225								
 巻掛本数	[本]	10*8	6	4	6	4	4	4	4	4	4







(単位 : ton)

ブーム 	ジブ	アウトリガ  6.3m	作業範囲 
--	----	--	---



 [m]	7.5	12.5		17.5		22.5		27.5		32.5	
 [m]	2.6	34.00*	19.00	12.00	17.00	9.00	12.00	7.00			
	3.0	31.00*	19.00	12.00	17.00	9.00	12.00	7.00			
	3.5	27.50	19.00	12.00	17.00	9.00	12.00	7.00	9.00	7.00	
	4.0	24.50	19.00	12.00	17.00	9.00	12.00	7.00	9.00	7.00	
	4.5	22.50	19.00	12.00	17.00	9.00	12.00	7.00	9.00	7.00	
	5.0	20.50	19.00	11.65	17.00	8.55	12.00	7.00	9.00	7.00	
	5.5		18.50	10.95	15.85	8.00	12.00	6.90	9.00	7.00	
	6.0		17.00	10.40	14.80	7.50	12.00	6.45	9.00	7.00	
	6.5		15.50	9.85	13.80	7.05	12.00	6.05	9.00	7.00	
	7.0		13.75	9.40	12.95	6.70	11.50	5.70	9.00	6.80	
	8.0		10.35	8.60	10.25	6.00	10.30	5.10	8.60	6.10	
	9.0		8.15	7.95	8.00	5.45	8.75	4.60	7.80	5.55	
	10.0		6.55	7.50	6.45	5.00	7.15	4.15	7.10	5.05	
	11.0				5.25	4.60	5.90	3.75	6.35	4.65	
	12.0				4.35	4.25	4.95	3.40	5.35	4.25	
	13.0				3.60	3.95	4.20	3.10	4.60	3.90	
	14.0				3.00	3.65	3.60	2.85	3.95	3.60	
	15.0				2.50	3.35	3.05	2.65	3.45	3.30	
	16.0						2.65	2.45	3.00	3.05	
	17.0						2.25	2.25	2.60	2.85	
18.0						1.90	2.10	2.25	2.70		
19.0						1.60	2.00	2.00	2.45		
20.0						1.35	1.85	1.70	2.20		
22.0								1.25	1.75		
24.0								0.90	1.40		
26.0									0.80		
28.0									0.55		
	ブーム2 (%)	0	50	0	100	0	100	0	100	50	100
	ブーム3 (%)	0	50	0	100	0	100	0	100	50	100
	ブーム4 (%)	0	0	33	0	66	33	100	66	100	100
	ブーム5 (%)	0	0	33	0	66	33	100	66	100	100
	ブーム6 (%)	0	0	33	0	66	33	100	66	100	100
	MODE	A,B	A	B	A	B	A	B	A	B	A,B
 危険角度	[°]	-	-	-	-	-	-	-	-	-	6
 標準フック	[ton]	35	22								
 フック質量	[kg]	310	225								
 巻掛本数	[本]	10*/8	6	4	6	4	4	4	4	4	4







(単位 : ton)

ブーム 	ジブ	アウトリガ  5.2m	作業範囲 
--	----	--	---

 [m]	7.5	12.5		17.5		22.5		27.5		32.5	
 [m]	2.6	30.00	19.00	12.00	17.00	9.00	12.00	7.00			
	3.0	28.50	19.00	12.00	17.00	9.00	12.00	7.00			
	3.5	25.50	19.00	12.00	17.00	9.00	12.00	7.00	9.00	7.00	
	4.0	22.50	19.00	12.00	17.00	9.00	12.00	7.00	9.00	7.00	
	4.5	20.50	19.00	12.00	17.00	9.00	12.00	7.00	9.00	7.00	7.00
	5.0	18.50	18.50	11.65	17.00	8.55	12.00	7.00	9.00	7.00	7.00
	5.5		15.40	10.95	15.30	8.00	12.00	6.90	9.00	7.00	7.00
	6.0		12.80	10.40	12.70	7.50	12.00	6.45	9.00	7.00	7.00
	6.5		10.85	9.85	10.75	7.05	11.55	6.05	9.00	7.00	7.00
	7.0		9.30	9.40	9.20	6.70	10.00	5.70	9.00	6.80	7.00
	8.0		7.10	8.45	7.00	6.00	7.70	5.10	8.20	6.10	7.00
	9.0		5.55	6.85	5.45	5.45	6.15	4.60	6.60	5.55	6.45
	10.0		4.45	5.65	4.35	5.00	4.95	4.15	5.40	5.05	5.65
	11.0				3.50	4.60	4.10	3.75	4.50	4.65	4.75
	12.0				2.80	4.25	3.40	3.40	3.75	4.25	4.00
	13.0				2.30	3.80	2.85	3.10	3.20	3.65	3.40
	14.0				1.85	3.35	2.35	2.85	2.70	3.15	2.95
	15.0				1.45	2.95	2.00	2.65	2.30	2.75	2.55
	16.0						1.65	2.45	1.95	2.40	2.20
	17.0						1.35	2.25	1.70	2.10	1.90
	18.0						1.05	2.10	1.40	1.85	1.65
	19.0						0.85	1.95	1.20	1.65	1.40
	20.0						0.60	1.80	0.95	1.45	1.20
	22.0								0.60	1.10	0.80
24.0									0.80	0.50	
	ブーム2 (%)	0	50	0	100	0	100	0	100	50	100
	ブーム3 (%)	0	50	0	100	0	100	0	100	50	100
	ブーム4 (%)	0	0	33	0	66	33	100	66	100	100
	ブーム5 (%)	0	0	33	0	66	33	100	66	100	100
	ブーム6 (%)	0	0	33	0	66	33	100	66	100	100
	MODE	A,B	A	B	A	B	A	B	A	B	A,B
 危険角度	[°]	-	-	-	-	-	-	-	24	-	35
 標準フック	[ton]	35	22								
 フック質量	[kg]	310	225								
 巻掛本数	[本]	8	6	4	6	4	4	4	4	4	4







(単位 : ton)

ブーム 	ジブ	アウトリガ  4.2m	作業範囲 
--	----	--	---

 [m]		7.5	12.5	17.5	22.5	27.5	32.5					
 [m]	2.6	29.00	19.00	12.00	17.00	9.00	12.00	7.00				
	3.0	26.00	19.00	12.00	17.00	9.00	12.00	7.00				
	3.5	23.00	19.00	12.00	17.00	9.00	12.00	7.00	9.00	7.00		
	4.0	19.00	19.00	12.00	17.00	9.00	12.00	7.00	9.00	7.00		
	4.5	15.35	15.15	12.00	14.75	9.00	12.00	7.00	9.00	7.00	7.00	
	5.0	12.30	12.15	11.65	12.05	8.55	12.00	7.00	9.00	7.00	7.00	
	5.5		10.00	10.95	9.90	8.00	10.60	6.90	9.00	7.00	7.00	
	6.0		8.40	9.80	8.30	7.50	9.05	6.45	9.00	7.00	7.00	
	6.5		7.15	8.50	7.05	7.05	7.80	6.05	8.20	7.00	7.00	
	7.0		6.15	7.45	6.05	6.70	6.75	5.70	7.25	6.80	7.00	
	8.0		4.65	5.85	4.60	6.00	5.20	5.10	5.65	6.10	5.95	
	9.0		3.60	4.75	3.50	5.10	4.10	4.60	4.50	5.00	4.80	
	10.0		2.80	3.90	2.75	4.25	3.30	4.15	3.65	4.15	3.90	
	11.0				2.10	3.60	2.65	3.75	3.00	3.45	3.25	
	12.0				1.60	3.05	2.15	3.25	2.50	2.95	2.70	
	13.0				1.20	2.65	1.75	2.80	2.05	2.50	2.30	
	14.0				0.85	2.30	1.40	2.45	1.70	2.15	1.90	
	15.0				0.50	2.00	1.10	2.15	1.40	1.80	1.60	
	16.0						0.80	1.85	1.15	1.55	1.35	
	17.0						0.55	1.65	0.90	1.35	1.10	
	18.0							1.45	0.70	1.15	0.90	
	19.0							1.30		0.95	0.75	
20.0							1.15		0.80			
22.0									0.50			
	ブーム2(%)	0	50	0	100	0	100	0	100	50	100	
	ブーム3(%)	0	50	0	100	0	100	0	100	50	100	
	ブーム4(%)	0	0	33	0	66	33	100	66	100	100	
	ブーム5(%)	0	0	33	0	66	33	100	66	100	100	
	ブーム6(%)	0	0	33	0	66	33	100	66	100	100	
	MODE	A,B	A	B	A	B	A	B	A	B	A,B	
 危険角度	[°]	-	-	-	-	-	28	-	41	25	50	
 標準フック	[ton]	35	22									
 フック質量	[kg]	310	225									
 巻掛本数	[本]	8	6	4	6	4	4	4	4	4	4	

























(単位 : ton)

ブーム 	ジブ	アウトリガ  2.31m	作業範囲 
--	----	---	---













 [m]	7.5	12.5		17.5		22.5		27.5		32.5	
 [m]	2.6	15.70	15.10	12.00	12.85	9.00	12.00	7.00			
	3.0	11.90	11.75	12.00	10.45	9.00	10.25	7.00			
	3.5	8.90	8.80	10.25	8.30	9.00	8.35	7.00	7.00	7.00	
	4.0	6.95	6.80	8.15	6.70	8.65	6.90	7.00	5.95	6.60	
	4.5	5.55	5.40	6.70	5.35	7.10	5.80	7.00	5.10	5.75	4.95
	5.0	4.55	4.40	5.60	4.35	6.00	4.90	6.25	4.40	5.05	4.30
	5.5		3.60	4.75	3.55	5.15	4.15	5.35	3.80	4.45	3.80
	6.0		2.95	4.05	2.90	4.45	3.50	4.65	3.30	3.95	3.30
	6.5		2.45	3.50	2.35	3.85	2.95	4.05	2.90	3.50	2.90
	7.0		2.00	3.05	1.95	3.40	2.50	3.60	2.50	3.10	2.55
	8.0		1.35	2.35	1.25	2.65	1.80	2.85	1.90	2.45	2.00
	9.0			1.80		2.10	1.25	2.30	1.40	1.95	1.50
	10.0			1.40		1.70		1.85		1.55	
	11.0					1.35		1.50		1.20	
	12.0					1.10		1.25		0.90	
	13.0					0.85		1.00			
14.0					0.70		0.80				
15.0					0.55		0.65				
16.0							0.50				
	ブーム2 (%)	0	50	0	100	0	100	0	100	50	100
	ブーム3 (%)	0	50	0	100	0	100	0	100	50	100
	ブーム4 (%)	0	0	33	0	66	33	100	66	100	100
	ブーム5 (%)	0	0	33	0	66	33	100	66	100	100
	ブーム6 (%)	0	0	33	0	66	33	100	66	100	100
	MODE	A,B	A	B	A	B	A	B	A	B	A,B
 危険角度	[°]	-	36	-	56	-	62	32	67	60	71
 標準フック	[ton]	35	22								
 フック質量	[kg]	310	225								
 巻掛本数	[本]	8	6	4	6	4	4	4	4	4	4

(単位 : ton)























 ブーム	 ジブ 6.5m	 アウトリガ 6.8m	 作業範囲
--	--	--	---

 [m]	17.5								17.5									
	7		25		45		60		[°]	7		25		45		60		
	 [°]	 (m)  (ton)	 (m)  (ton)	 (m)  (ton)	 (m)  (ton)	 (m)  (ton)	 (m)  (ton)	 (m)  (ton)		 (m)  (ton)	 (m) (ton)	(m) (ton)	(m) (ton)	(m) (ton)	(m) (ton)	(m) (ton)	(m) (ton)	
84.0	2.2	3.20	4.2	3.20	5.9	2.52	6.7	1.69	84.0	2.2	3.20	4.3	3.20	6.0	2.52	6.7	1.69	
80.0	3.9	3.20	5.8	3.20	7.4	2.41	8.1	1.65	80.0	4.0	3.20	5.9	3.20	7.5	2.40	8.1	1.65	
75.0	6.0	3.20	7.7	3.20	9.1	2.30	9.7	1.62	75.0	6.1	3.20	7.9	3.20	9.2	2.29	9.8	1.62	
70.0	8.0	3.20	9.6	3.20	10.8	2.22	11.2	1.60	70.0	8.0	3.20	9.7	2.82	10.9	2.22	11.3	1.60	
66.0	9.5	3.20	11.0	3.09	12.1	2.17	12.4	1.59	66.0	9.6	3.20	11.1	2.56	12.2	2.16	12.4	1.58	
63.0	10.6	3.20	12.1	2.99	13.0	2.16	13.2	1.58	63.0	10.6	3.01	12.1	2.41	13.0	2.08	13.2	1.58	
60.0	11.6	3.20	13.0	2.90	13.9	2.14			60.0	11.7	2.73	13.0	2.26	13.9	2.01			
55.0	13.3	3.20	14.6	2.78	15.2	2.13			55.0	13.3	2.36	14.5	2.01	15.2	1.85			
50.0	14.9	3.20	16.0	2.70	16.4	2.13			50.0	14.8	2.07	15.9	1.81	16.4	1.72			
46.0	16.0	2.91	17.0	2.65	17.3	2.10			46.0	15.9	1.89	16.9	1.69	17.2	1.62			
40.0	17.5	2.26	18.3	2.16					40.0	17.5	1.68	18.2	1.55					
35.0	18.6	1.87	19.2	1.80					35.0	18.6	1.55	19.1	1.45					
30.0	19.6	1.57	20.0	1.54					30.0	19.5	1.44	19.9	1.38					
26.0	20.2	1.36	20.5	1.32					26.0	20.2	1.38	20.4	1.28					
20.0	21.0	1.15							20.0	20.9	1.31							
15.0	21.5	1.03							15.0	21.4	1.19							
8.0	21.7	0.97							8.0	21.6	1.13							
	ブーム2 (%)	100								ブーム2 (%)	0							
	ブーム3 (%)	100								ブーム3 (%)	0							
	ブーム4 (%)	0								ブーム4 (%)	66							
	ブーム5 (%)	0								ブーム5 (%)	66							
	ブーム6 (%)	0								ブーム6 (%)	66							
	MODE	A								MODE	B							
 危険角度	[°]	7	25	45	62	[°]	7	25	45	62								
 標準フック	[ton]	4.5								[ton]	4.5							
 フック質量	kg	70								kg	70							
 巻掛本数	[本]	1								[本]	1							

















ブーム 	ジブ  6.5m	アウトリガ  6.8m	作業範囲 
--	--	--	---

 [m]	32.5								
	7		25		45		60		
 [°]									
	 [°]	 (m)	 (ton)	 (m)	 (ton)	 (m)	 (ton)	 (m)	 (ton)
84.0	4.8	3.20	7.1	3.20	8.7	2.46	9.2	1.66	
82.0	6.4	3.20	8.6	3.20	10.1	2.40	10.5	1.65	
76.0	11.0	3.20	12.7	2.59	14.3	2.05	14.2	1.60	
70.0	14.9	2.54	16.3	2.06	17.4	1.80	17.6	1.57	
66.0	17.3	2.14	18.6	1.79	19.6	1.59	19.7	1.54	
63.0	19.0	1.90	20.3	1.62	21.1	1.45	21.0	1.45	
60.0	20.7	1.70	21.9	1.46	22.6	1.34			
56.0	22.7	1.27	23.9	1.17	24.5	1.15			
50.0	25.3	0.77	26.5	0.70	26.9	0.70			
46.0	26.9	0.53	28.2	0.45	28.3	0.45			
44.0	28.1	0.36	28.9	0.35					
	ブーム2 (%)	100							
	ブーム3 (%)	100							
	ブーム4 (%)	100							
	ブーム5 (%)	100							
	ブーム6 (%)	100							
	MODE	A,B							
	危険角度 [°]	43		43		45		62	
標準フック [ton]	4.5								
フック質量 kg	70								
巻掛本数 [本]	1								





























 ブーム	 ジブ 6.5m	 アウトリガ 6.3m	 作業範囲
--	--	--	---

 [m]	17.5								17.5									
	7		25		45		60		[°]	7		25		45		60		
	 (m)	 (ton)	 (m)	 (ton)	 (m)	 (ton)	 (m)	 (ton)		 (m)	 (ton)	 (m)	 (ton)	 (m)	 (ton)	 (m)	 (ton)	
84.0	2.2	3.20	4.2	3.20	5.9	2.52	6.7	1.69	84.0	2.2	3.20	4.3	3.20	6.0	2.52	6.7	1.69	
80.0	3.9	3.20	5.8	3.20	7.4	2.41	8.1	1.65	80.0	4.0	3.20	5.9	3.20	7.5	2.40	8.1	1.65	
75.0	6.0	3.20	7.7	3.20	9.1	2.30	9.7	1.62	75.0	6.1	3.20	7.9	3.20	9.2	2.29	9.8	1.62	
70.0	8.0	3.20	9.6	3.20	10.8	2.22	11.2	1.60	70.0	8.0	3.20	9.7	2.82	10.9	2.22	11.3	1.60	
66.0	9.5	3.20	11.0	3.09	12.1	2.17	12.4	1.59	66.0	9.6	3.20	11.1	2.56	12.2	2.16	12.4	1.58	
63.0	10.6	3.20	12.0	2.99	13.0	2.16	13.2	1.58	63.0	10.6	3.01	12.1	2.41	13.0	2.08	13.2	1.58	
60.0	11.6	3.20	13.1	2.90	13.9	2.14			60.0	11.7	2.73	13.0	2.26	13.9	2.01			
55.0	13.3	3.20	14.6	2.78	15.2	2.13			55.0	13.3	2.36	14.5	2.01	15.2	1.85			
50.0	14.9	2.98	16.0	2.70	16.4	2.13			50.0	14.8	2.07	15.9	1.81	16.4	1.72			
46.0	16.0	2.44	16.9	2.27	17.3	2.10			46.0	15.9	1.89	16.9	1.69	17.2	1.62			
40.0	17.5	1.86	18.2	1.77					40.0	17.5	1.68	18.2	1.55					
35.0	18.6	1.49	19.2	1.45					35.0	18.6	1.55	19.1	1.45					
30.0	19.6	1.21	20.0	1.20					30.0	19.5	1.44	19.9	1.38					
26.0	20.2	1.02	20.5	0.98					26.0	20.2	1.38	20.4	1.28					
20.0	21.0	0.83							20.0	20.9	1.31							
15.0	21.5	0.72							15.0	21.4	1.19							
8.0	21.7	0.67							8.0	21.6	1.13							
	ブーム2 (%)	100								ブーム2 (%)	0							
	ブーム3 (%)	100								ブーム3 (%)	0							
	ブーム4 (%)	0								ブーム4 (%)	66							
	ブーム5 (%)	0								ブーム5 (%)	66							
	ブーム6 (%)	0								ブーム6 (%)	66							
	MODE	A								MODE	B							
 危険角度 [°]	7	25	45	62					[°]	7	25	45	62					
 標準フック [ton]	4.5								[ton]	4.5								
 フック質量 kg	70								kg	70								
 巻掛本数 [本]	1								[本]	1								

















 ブーム	 ジブ 6.5m	 アウトリガ 6.3m	 作業範囲
---	---	---	--

 [m]	32.5								
	7		25		45		60		
 [°]									
 [°]									
	(m)	(ton)	(m)	(ton)	(m)	(ton)	(m)	(ton)	
84.0	4.8	3.20	7.1	3.20	8.7	2.46	9.2	1.66	
82.0	6.4	3.20	8.6	3.20	10.1	2.40	10.5	1.65	
76.0	11.0	3.20	12.7	2.59	14.3	2.05	14.2	1.60	
70.0	14.9	2.54	16.3	2.06	17.4	1.80	17.6	1.57	
66.0	17.3	2.14	18.6	1.79	19.6	1.59	19.7	1.54	
63.0	19.0	1.86	20.3	1.62	21.1	1.45	21.0	1.45	
60.0	20.5	1.44	21.8	1.32	22.6	1.26			
56.0	22.5	1.00	23.7	0.92	24.4	0.90			
50.0	25.4	0.50	26.4	0.47	26.8	0.47			
48.0	26.3	0.38	27.3	0.35	27.5	0.35			
	ブーム2 (%)	100							
	ブーム3 (%)	100							
	ブーム4 (%)	100							
	ブーム5 (%)	100							
	ブーム6 (%)	100							
	MODE	A,B							
 危険角度 [°]	47		47		47		62		
 標準フック [ton]	4.5								
 フック質量 kg	70								
 巻掛本数 [本]	1								























 ブーム	 ジブ 6.5m	 アウトリガ 5.2m	 作業範囲
--	--	--	---

 [m]	17.5								17.5												
	7		25		45		60		 [°]	7		25		45		60					
	 [°]	 (m) (ton)	 (m) (ton)	 (m) (ton)	 (m) (ton)	 (m) (ton)	 (m) (ton)	 (m) (ton)		 [°]	 (m) (ton)	 (m) (ton)	 (m) (ton)	 (m) (ton)	 (m) (ton)	 (m) (ton)	 (m) (ton)				
84.0	2.2	3.20	4.2	3.20	5.9	2.52	6.7	1.69	84.0	2.2	3.20	4.3	3.20	6.0	2.52	6.7	1.69				
80.0	3.9	3.20	5.8	3.20	7.4	2.41	8.1	1.65	80.0	4.0	3.20	5.9	3.20	7.5	2.40	8.1	1.65				
75.0	6.0	3.20	7.7	3.20	9.1	2.30	9.7	1.62	75.0	6.1	3.20	7.9	3.20	9.2	2.29	9.8	1.62				
70.0	8.0	3.20	9.6	3.20	10.8	2.22	11.2	1.60	70.0	8.0	3.20	9.7	2.82	10.9	2.22	11.3	1.60				
66.0	9.5	3.20	11.0	3.09	12.1	2.17	12.4	1.59	66.0	9.6	3.20	11.1	2.56	12.2	2.16	12.4	1.58				
63.0	10.6	3.20	12.1	2.99	13.0	2.16	13.2	1.58	63.0	10.6	3.01	12.1	2.41	13.0	2.08	13.2	1.58				
60.0	11.6	3.20	13.0	2.90	13.9	2.14			60.0	11.7	2.73	13.0	2.26	13.9	2.01						
55.0	13.3	2.60	14.5	2.28	15.2	2.13			55.0	13.3	2.36	14.5	2.01	15.2	1.85						
50.0	14.8	1.87	15.9	1.70	16.4	1.65			50.0	14.8	2.07	15.9	1.81	16.4	1.72						
46.0	15.9	1.45	16.9	1.34	17.2	1.33			46.0	15.9	1.89	16.9	1.69	17.2	1.62						
40.0	17.4	0.98	18.2	0.93					40.0	17.5	1.68	18.2	1.55								
35.0	18.5	0.68	19.2	0.66					35.0	18.6	1.55	19.1	1.45								
30.0	19.5	0.45	20.0	0.45					30.0	19.5	1.44	19.9	1.38								
28.0	19.9	0.37	20.2	0.37					28.0	19.9	1.41	20.4	1.28								
27.0	20.0	0.33							27.0	20.0	1.39										
									26.0	20.2	1.38										
									20.0	20.9	1.26										
									15.0	21.4	1.18										
									8.0	21.6	1.13										
 ブーム2 (%)	100								ブーム2 (%)	0											
	 ブーム3 (%)	100								ブーム3 (%)	0										
		 ブーム4 (%)	0								ブーム4 (%)	66									
			 ブーム5 (%)	0								ブーム5 (%)	66								
				 ブーム6 (%)	0								ブーム6 (%)	66							
					MODE	A								MODE	B						
 危険角度 [°]	26	27	45	62					 [°]	7	25	45	62								
 標準フック [ton]	4.5								[ton]	4.5											
 フック質量 kg	70								kg	70											
 巻掛本数 [本]	1								[本]	1											

















 ブーム	 ジブ 6.5m	 アウトリガ 5.2m	 作業範囲
---	---	---	--

 [m]	32.5								
 [°]	7		25		45		60		
 [°]									
	(m)	(ton)	(m)	(ton)	(m)	(ton)	(m)	(ton)	
84.0	4.8	3.20	7.1	3.20	8.7	2.46	9.2	1.66	
82.0	6.4	3.20	8.6	3.20	10.1	2.40	10.5	1.65	
76.0	11.0	3.20	12.7	2.59	14.3	2.05	14.2	1.60	
70.0	14.9	2.34	16.3	2.06	17.4	1.80	17.6	1.57	
66.0	17.0	1.58	18.4	1.40	19.5	1.30	19.6	1.30	
63.0	18.6	1.13	20.0	1.01	20.9	0.95	20.9	0.95	
60.0	20.2	0.77	21.5	0.69	22.3	0.66			
59.0	20.7	0.67	22.0	0.60	22.8	0.58			
	ブーム2 (%)	100							
	ブーム3 (%)	100							
	ブーム4 (%)	100							
	ブーム5 (%)	100							
	ブーム6 (%)	100							
	MODE	A,B							
 危険角度 [°]	58		58		58		62		
 標準フック [ton]	4.5								
 フック質量 kg	70								
 巻掛本数 [本]	1								























 ブーム	 ジブ 6.5m	 アウトリガ 4.2m	 作業範囲
--	--	--	---

 [m]	17.5								17.5									
	7		25		45		60		[°]	7		25		45		60		
	 [°]	 (m) (ton)	 (m) (ton)	 (m) (ton)	 (m) (ton)	 (m) (ton)	 (m) (ton)	 (m) (ton)		 (m) (ton)	 (m) (ton)	 (m) (ton)	 (m) (ton)	 (m) (ton)	 (m) (ton)	 (m) (ton)	 (m) (ton)	 (m) (ton)
84.0	2.2	3.20	4.2	3.20	5.9	2.52	6.7	1.69	84.0	2.2	3.20	4.3	3.20	6.0	2.52	6.7	1.69	
80.0	3.9	3.20	5.8	3.20	7.4	2.41	8.1	1.65	80.0	4.0	3.20	5.9	3.20	7.5	2.40	8.1	1.65	
75.0	6.0	3.20	7.7	3.20	9.1	2.30	9.7	1.62	75.0	6.1	3.20	7.9	3.20	9.2	2.29	9.8	1.62	
70.0	8.0	3.20	9.6	3.20	10.8	2.22	11.2	1.60	70.0	8.0	3.20	9.7	2.82	10.9	2.22	11.3	1.60	
66.0	9.5	3.20	11.1	3.00	12.1	2.17	12.4	1.59	66.0	9.6	3.20	11.1	2.56	12.2	2.16	12.4	1.58	
63.0	10.5	2.94	12.1	2.42	13.0	2.16	13.2	1.58	63.0	10.6	3.01	12.1	2.41	13.0	2.08	13.2	1.58	
60.0	11.6	2.34	13.0	1.99	13.8	1.85			60.0	11.7	2.73	13.0	2.26	13.9	2.01			
55.0	13.2	1.57	14.5	1.35	15.2	1.28			55.0	13.3	2.36	14.5	2.01	15.2	1.85			
50.0	14.7	0.99	15.8	0.88	16.4	0.86			50.0	14.8	2.01	15.9	1.81	16.4	1.72			
46.0	15.8	0.65	16.8	0.60	17.2	0.59			46.0	15.9	1.70	16.8	1.58	17.2	1.55			
42.0	16.8	0.39	17.7	0.36					42.0	16.9	1.46	17.7	1.37					
41.0	17.1	0.33							41.0	17.2	1.40	18.0	1.33					
									40.0	17.4	1.34	18.2	1.28					
									35.0	18.5	1.10	19.1	1.07					
									30.0	19.5	0.92	19.9	0.91					
									26.0	20.1	0.80	20.4	0.78					
									20.0	20.9	0.67							
									15.0	21.4	0.60							
									8.0	21.6	0.56							
 ブーム2 (%)	100								ブーム2 (%)	0								
	 危険角度	100								ブーム3 (%)	0							
		0								ブーム4 (%)	66							
		0								ブーム5 (%)	66							
		0								ブーム6 (%)	66							
		A								MODE	B							
 標準フック	4.5								[ton]	4.5								
 フック質量	70								kg	70								
 巻掛本数	1								[本]	1								











ブーム 	ジブ  6.5m	アウトリガ  4.2m	作業範囲 
--	--	--	---

 [m]	32.5							
 [°]	7		25		45		60	
 [°]								
	(m)	(ton)	(m)	(ton)	(m)	(ton)	(m)	(ton)
84.0	4.8	3.20	7.1	3.20	8.7	2.46	9.2	1.66
82.0	6.4	3.20	8.6	3.20	10.1	2.40	10.5	1.65
76.0	11.0	3.00	12.7	2.57	14.3	2.05	14.2	1.60
70.0	14.4	1.56	16.0	1.34	17.1	1.22	17.5	1.20
67.0	16.1	1.05	17.6	0.90	18.7	0.82	18.9	0.82
	ブーム2 (%)	100						
	ブーム3 (%)	100						
	ブーム4 (%)	100						
	ブーム5 (%)	100						
	ブーム6 (%)	100						
	MODE	A,B						
 [°]	66		66		66		66	
危険角度								
 [ton]	4.5							
標準フック								
 kg	70							
フック質量								
 [本]	1							
巻掛本数								





















 ブーム	 ジブ 10.25m	 アウトリガ 6.8m	 作業範囲
--	--	--	---

 [m]	17.5								17.5									
	5		25		45		60		[°]	5		25		45		60		
	 (m)	 (ton)	 (m)	 (ton)	 (m)	 (ton)	 (m)	 (ton)		 (m)	 (ton)	 (m)	 (ton)	 (m)	 (ton)	 (m)	 (ton)	
84.0	2.7	2.00	6.2	1.90	8.9	1.34	10.2	0.95	84.0	2.9	2.00	6.4	1.90	9.0	1.33	10.3	0.94	
80.0	4.7	2.00	8.1	1.89	10.5	1.28	11.6	0.92	80.0	4.9	2.00	8.3	1.87	10.7	1.26	11.8	0.91	
75.0	7.2	2.00	10.3	1.74	12.5	1.21	13.4	0.90	75.0	7.3	2.00	10.5	1.73	12.6	1.20	13.5	0.89	
70.0	9.5	2.00	12.4	1.61	14.3	1.17	15.0	0.89	70.0	9.7	2.00	12.6	1.61	14.4	1.15	15.0	0.88	
66.0	11.2	2.00	13.9	1.53	15.6	1.13	16.1	0.88	66.0	11.4	2.00	14.1	1.52	15.7	1.12	16.2	0.88	
63.0	12.5	2.00	15.1	1.47	16.6	1.12	16.8	0.88	63.0	12.7	1.95	15.3	1.47	16.7	1.11	16.8	0.88	
60.0	13.7	1.90	16.1	1.43	17.5	1.11			60.0	13.9	1.85	16.3	1.42	17.5	1.10			
55.0	15.6	1.71	17.8	1.40	18.9	1.09			55.0	15.8	1.67	18.0	1.37	18.9	1.09			
50.0	17.4	1.58	19.3	1.35	20.1	1.08			50.0	17.6	1.53	19.5	1.27	20.1	1.08			
46.0	18.7	1.49	20.5	1.31	21.0	1.08			46.0	18.9	1.39	20.6	1.19	20.9	1.08			
40.0	20.6	1.39	21.9	1.28					40.0	20.7	1.24	22.0	1.10					
35.0	21.9	1.32	22.9	1.26					35.0	21.9	1.14	22.9	1.04					
30.0	23.0	1.23	23.7	1.21					30.0	23.0	1.06	23.7	1.00					
26.0	23.7	1.07	24.3	1.04					26.0	23.8	1.01	24.2	0.97					
20.0	24.6	0.90							20.0	24.7	0.96							
15.0	25.1	0.81							15.0	25.2	0.93							
6.0	25.5	0.75							6.0	25.4	0.90							
 危険角度	ブーム2 (%)	100								ブーム2 (%)	0							
	ブーム3 (%)	100								ブーム3 (%)	0							
	ブーム4 (%)	0								ブーム4 (%)	66							
	ブーム5 (%)	0								ブーム5 (%)	66							
	ブーム6 (%)	0								ブーム6 (%)	66							
	MODE	A								MODE	B							
 危険角度	[°]	5	25	45	62	[°]	5	25	45	62								
 標準フック	[ton]	4.5								[ton]	4.5							
 フック質量	kg	70								kg	70							
 巻掛本数	[本]	1								[本]	1							

















 ブーム	 ジブ 10.25m	 アウトリガ 6.8m	 作業範囲
---	---	---	--

 [m]	32.5								
	5		25		45		60		
 [°]									
	 (m)	 (ton)	 (m)	 (ton)	 (m)	 (ton)	 (m)	 (ton)	
84.0	5.6	2.00	9.4	1.90	11.6	1.25	12.8	0.91	
80.0	9.0	2.00	12.5	1.78	14.5	1.20	15.4	0.90	
75.0	13.1	2.00	16.0	1.60	17.8	1.14	18.4	0.88	
71.0	16.0	2.00	18.7	1.44	20.3	1.11	20.6	0.87	
66.0	19.5	1.66	21.8	1.25	23.2	1.07	23.3	0.86	
63.0	21.4	1.47	23.6	1.15	24.8	1.01	24.4	0.86	
60.0	23.2	1.32	25.3	1.04	26.3	0.94			
55.0	25.9	0.94	27.9	0.86	28.6	0.83			
50.0	28.4	0.58	30.2	0.54	30.7	0.54			
46.0	30.3	0.36	31.8	0.34	32.1	0.34			
45.0	30.7	0.31	32.2	0.30					
	ブーム2 (%)	100							
	ブーム3 (%)	100							
	ブーム4 (%)	100							
	ブーム5 (%)	100							
	ブーム6 (%)	100							
	MODE	A,B							
	危険角度 [°]	44		44		45		62	
標準フック [ton]	4.5								
フック質量 kg	70								
巻掛本数 [本]	1								





























 ブーム	 ジブ 10.25m	 アウトリガ 6.3m	 作業範囲
--	--	--	---

 [m]	17.5								17.5									
	5		25		45		60		[°]	5		25		45		60		
	 (m)	 (ton)	 (m)	 (ton)	 (m)	 (ton)	 (m)	 (ton)		 (m)	 (ton)	 (m)	 (ton)	 (m)	 (ton)			
84.0	2.7	2.00	6.2	1.90	8.9	1.34	10.2	0.95	84.0	2.9	2.00	6.4	1.90	9.0	1.33	10.3	0.94	
80.0	4.7	2.00	8.1	1.89	10.5	1.28	11.6	0.92	80.0	4.9	2.00	8.3	1.87	10.7	1.26	11.8	0.91	
75.0	7.2	2.00	10.3	1.74	12.5	1.21	13.4	0.90	75.0	7.3	2.00	10.5	1.73	12.6	1.20	13.5	0.89	
70.0	9.5	2.00	12.4	1.61	14.3	1.17	15.0	0.89	70.0	9.7	2.00	12.6	1.61	14.4	1.15	15.0	0.88	
66.0	11.2	2.00	13.9	1.53	15.6	1.13	16.1	0.88	66.0	11.4	2.00	14.1	1.52	15.7	1.12	16.2	0.88	
63.0	12.5	2.00	15.1	1.47	16.6	1.12	16.8	0.88	63.0	12.7	1.95	15.3	1.47	16.7	1.11	16.8	0.88	
60.0	13.7	1.90	16.1	1.43	17.5	1.11			60.0	13.9	1.85	16.3	1.42	17.5	1.10			
55.0	15.6	1.71	17.8	1.40	18.9	1.09			55.0	15.8	1.67	18.0	1.37	18.9	1.09			
50.0	17.4	1.58	19.3	1.35	20.1	1.08			50.0	17.6	1.53	19.5	1.27	20.1	1.08			
46.0	18.7	1.49	20.5	1.31	21.0	1.08			46.0	18.9	1.39	20.6	1.19	20.9	1.08			
40.0	20.6	1.39	21.9	1.28					40.0	20.7	1.24	22.0	1.10					
35.0	21.8	1.17	22.9	1.12					35.0	21.9	1.14	22.9	1.04					
30.0	22.9	0.94	23.7	0.93					30.0	23.0	1.06	23.7	1.00					
26.0	23.7	0.79	24.3	0.77					26.0	23.8	1.01	24.2	0.97					
20.0	24.6	0.64							20.0	24.7	0.96							
15.0	25.1	0.55							15.0	25.2	0.93							
6.0	25.5	0.49							6.0	25.4	0.90							
	ブーム2 (%)	100								ブーム2 (%)	0							
	ブーム3 (%)	100								ブーム3 (%)	0							
	ブーム4 (%)	0								ブーム4 (%)	66							
	ブーム5 (%)	0								ブーム5 (%)	66							
	ブーム6 (%)	0								ブーム6 (%)	66							
	MODE	A								MODE	B							
 危険角度 [°]	5	25	45	62					[°]	5	25	45	62					
 標準フック [ton]	4.5								[ton]	4.5								
 フック質量 kg	70								kg	70								
 巻掛本数 [本]	1								[本]	1								

















ブーム 	ジブ  10.25m	アウトリガ  6.3m	作業範囲 
--	--	--	---

 [m]	32.5								
	5		25		45		60		
 [°]									
 [°]	 (m)	 (ton)	 (m)	 (ton)	 (m)	 (ton)	 (m)	 (ton)	
	84.0	5.6	2.00	9.4	1.90	11.6	1.25	12.8	0.91
80.0	9.0	2.00	12.5	1.78	14.5	1.20	15.4	0.90	
75.0	13.1	2.00	16.0	1.60	17.8	1.14	18.4	0.88	
71.0	16.0	2.00	18.7	1.44	20.3	1.11	20.6	0.87	
66.0	19.5	1.66	21.8	1.25	23.2	1.07	23.3	0.86	
63.0	21.4	1.47	23.6	1.15	24.8	1.01	24.4	0.86	
60.0	23.2	1.14	25.3	1.02	26.3	0.94			
55.0	25.8	0.71	27.7	0.65	28.5	0.65			
50.0	28.3	0.38	30.0	0.36	30.5	0.36			
	ブーム2 (%)	100							
	ブーム3 (%)	100							
	ブーム4 (%)	100							
	ブーム5 (%)	100							
	ブーム6 (%)	100							
	MODE	A,B							
 危険角度 [°]	49		49		49		62		
 標準フック [ton]	4.5								
 フック質量 [kg]	70								
 巻掛本数 [本]	1								





























 ブーム	 ジブ 10.25m	 アウトリガ 5.2m	 作業範囲
--	--	--	---

 [m]	17.5								17.5									
	5		25		45		60		[°]	5		25		45		60		
	 (m)  (ton)	 (m)  (ton)	 (m)  (ton)	 (m)  (ton)	 (m)  (ton)	 (m)  (ton)	 (m)  (ton)	 (m)  (ton)		 (m)  (ton)	 (m)  (ton)	 (m)  (ton)	(m) (ton)	(m) (ton)	(m) (ton)	(m) (ton)	(m) (ton)	
84.0	2.7	2.00	6.2	1.90	8.9	1.34	10.2	0.95	84.0	2.9	2.00	6.4	1.90	9.0	1.33	10.3	0.94	
80.0	4.7	2.00	8.1	1.89	10.5	1.28	11.6	0.92	80.0	4.9	2.00	8.3	1.87	10.7	1.26	11.8	0.91	
75.0	7.2	2.00	10.3	1.74	12.5	1.21	13.4	0.90	75.0	7.3	2.00	10.5	1.73	12.6	1.20	13.5	0.89	
70.0	9.5	2.00	12.4	1.61	14.3	1.17	15.0	0.89	70.0	9.7	2.00	12.6	1.61	14.4	1.15	15.0	0.88	
66.0	11.2	2.00	13.9	1.53	15.6	1.13	16.1	0.88	66.0	11.4	2.00	14.1	1.52	15.7	1.12	16.2	0.88	
63.0	12.5	2.00	15.1	1.47	16.6	1.12	16.8	0.88	63.0	12.7	1.95	15.3	1.47	16.7	1.11	16.8	0.88	
60.0	13.7	1.90	16.1	1.43	17.5	1.11			60.0	13.9	1.85	16.3	1.42	17.5	1.10			
55.0	15.6	1.71	17.8	1.40	18.9	1.09			55.0	15.8	1.67	18.0	1.37	18.9	1.09			
50.0	17.4	1.47	19.3	1.28	20.1	1.08			50.0	17.6	1.53	19.5	1.27	20.1	1.08			
46.0	18.7	1.13	20.4	1.01	21.0	1.01			46.0	18.9	1.39	20.6	1.19	20.9	1.08			
40.0	20.4	0.75	21.9	0.69					40.0	20.7	1.24	22.0	1.10					
35.0	21.7	0.51	22.9	0.49					35.0	21.9	1.14	22.9	1.04					
31.0	22.7	0.35	23.6	0.35					31.0	22.8	1.08	23.6	1.01					
30.0	22.9	0.32							30.0	23.0	1.06	23.7	1.00					
									26.0	23.8	1.01	24.2	0.97					
									20.0	24.7	0.96							
									15.0	25.1	0.93							
									6.0	25.4	0.88							
	ブーム2 (%)	100								ブーム2 (%)	0							
	ブーム3 (%)	100								ブーム3 (%)	0							
	ブーム4 (%)	0								ブーム4 (%)	66							
	ブーム5 (%)	0								ブーム5 (%)	66							
	ブーム6 (%)	0								ブーム6 (%)	66							
	MODE	A								MODE	B							
 危険角度	[°]	29	30	45	62	[°]	5	25	45	62								
 標準フック	[ton]	4.5								[ton]	4.5							
 フック質量	kg	70								kg	70							
 巻掛本数	[本]	1								[本]	1							













ブーム 	ジブ  10.25m	アウトリガ  5.2m	作業範囲 
--	--	--	---





 [m]	32.5								
	5		25		45		60		
 [°]									
 [°]	 (m)	 (ton)	 (m)	 (ton)	 (m)	 (ton)	 (m)	 (ton)	
	84.0	5.6	2.00	9.4	1.90	11.6	1.25	12.8	0.91
80.0	9.0	2.00	12.5	1.78	14.5	1.20	15.4	0.90	
75.0	13.1	2.00	16.0	1.60	17.8	1.14	18.4	0.88	
71.0	16.0	2.00	18.7	1.44	20.3	1.11	20.6	0.87	
66.0	19.1	1.29	21.8	1.04	23.2	0.99	23.3	0.86	
63.0	20.8	0.91	23.3	0.77	24.6	0.73	24.4	0.72	
61.0	22.0	0.70	24.3	0.60	25.6	0.57			
	ブーム2 (%)	100							
	ブーム3 (%)	100							
	ブーム4 (%)	100							
	ブーム5 (%)	100							
	ブーム6 (%)	100							
	MODE	A,B							
	 [°]	60		60		60		62	
 [ton]	4.5								
 kg	70								
 [本]	1								

























 ブーム	 ジブ 10.25m	 アウトリガ 4.2m	 作業範囲
--	--	--	---

 [m]	17.5								17.5												
	5		25		45		60		 [°]	5		25		45		60					
	 (m)	 (ton)	 (m)	 (ton)	 (m)	 (ton)	 (m)	 (ton)		 [°]	 (m)	 (ton)	 (m)	 (ton)	 (m)	 (ton)	 (m)	 (ton)			
84.0	2.7	2.00	6.2	1.90	8.9	1.34	10.2	0.95	84.0	2.9	2.00	6.4	1.90	9.0	1.33	10.3	0.94				
80.0	4.7	2.00	8.1	1.89	10.5	1.28	11.6	0.92	80.0	4.9	2.00	8.3	1.87	10.7	1.26	11.8	0.91				
75.0	7.2	2.00	10.3	1.74	12.5	1.21	13.4	0.90	75.0	7.3	2.00	10.5	1.73	12.6	1.20	13.5	0.89				
70.0	9.5	2.00	12.4	1.61	14.3	1.17	15.0	0.89	70.0	9.7	2.00	12.6	1.61	14.4	1.15	15.0	0.88				
66.0	11.2	2.00	13.9	1.53	15.6	1.13	16.1	0.88	66.0	11.4	2.00	14.1	1.52	15.7	1.12	16.2	0.88				
63.0	12.5	2.00	15.1	1.47	16.6	1.12	16.8	0.88	63.0	12.7	1.95	15.3	1.47	16.7	1.11	16.8	0.88				
60.0	13.7	1.86	16.1	1.43	17.5	1.11			60.0	13.9	1.85	16.3	1.42	17.5	1.10						
55.0	15.6	1.22	17.8	1.00	18.8	0.95			55.0	15.8	1.67	18.0	1.37	18.9	1.09						
50.0	17.3	0.76	19.3	0.64	20.1	0.62			50.0	17.6	1.53	19.5	1.27	20.1	1.08						
46.0	18.6	0.48	20.3	0.42	20.9	0.42			46.0	18.9	1.34	20.6	1.19	20.9	1.08						
45.0	18.9	0.42	20.6	0.37					45.0	19.2	1.29	20.8	1.16								
43.0	19.5	0.31							43.0	19.8	1.18	21.2	1.08								
									40.0	20.6	1.04	21.9	0.97								
									35.0	21.9	0.85	22.9	0.82								
									30.0	23.0	0.70	23.7	0.69								
									26.0	23.7	0.60	24.2	0.60								
									20.0	24.6	0.50										
									15.0	25.2	0.44										
									6.0	25.4	0.41										
 ブーム2 (%)	100								ブーム2 (%)	0											
	 ブーム3 (%)	100								ブーム3 (%)	0										
		 ブーム4 (%)	0								ブーム4 (%)	66									
			 ブーム5 (%)	0								ブーム5 (%)	66								
				 ブーム6 (%)	0								ブーム6 (%)	66							
					MODE	A								MODE	B						
 危険角度	[°]	42	44	45	62	[°]	5	25	45	62											
 標準フック	[ton]	4.5								[ton]	4.5										
 フック質量	kg	70								kg	70										
 巻掛本数	[本]	1								[本]	1										











ブーム 	ジブ  10.25m	アウトリガ  4.2m	作業範囲 
--	--	--	---

 [m]	32.5							
	5		25		45		60	
 [°]								
 [°]	 (m)	 (ton)	 (m)	 (ton)	 (m)	 (ton)	 (m)	 (ton)
	84.0	5.6	2.00	9.4	1.90	11.6	1.25	12.8
80.0	9.0	2.00	12.5	1.78	14.5	1.20	15.4	0.90
75.0	13.1	2.00	16.0	1.60	17.8	1.14	18.4	0.88
71.0	15.7	1.40	18.5	1.13	20.3	0.99	20.6	0.87
69.0	16.9	1.09	19.6	0.87	21.2	0.79	21.7	0.79
68.0	17.5	0.95						
	ブーム2 (%)	100						
	ブーム3 (%)	100						
	ブーム4 (%)	100						
	ブーム5 (%)	100						
	ブーム6 (%)	100						
	MODE	A,B						
	危険角度 [°]	67		68		68		68
標準フック [ton]	4.5							
フック質量 kg	70							
巻掛本数 [本]	1							





















 ブーム	 ジブ 14.0m	 アウトリガ 6.8m	 作業範囲
--	---	--	---

 [m]	17.5								17.5											
	5		25		45		60		[°]	5		25		45		60				
	 (m)	 (ton)	 (m)	 (ton)	 (m)	 (ton)	 (m)	 (ton)		 (m)	 (ton)	 (m)	 (ton)	 (m)	 (ton)					
84.0	3.5	1.35	8.3	0.93	11.8	0.55	13.7	0.43	84.0	3.7	1.35	8.5	0.91	12.0	0.53	13.8	0.43			
80.0	5.9	1.35	10.4	0.86	13.6	0.52	15.2	0.42	80.0	6.1	1.35	10.5	0.83	13.8	0.51	15.3	0.42			
75.0	8.6	1.35	12.8	0.77	15.8	0.49	17.0	0.41	75.0	8.9	1.33	13.0	0.75	15.9	0.49	17.1	0.41			
70.0	11.2	1.20	15.1	0.70	17.7	0.47	18.7	0.41	70.0	11.5	1.18	15.3	0.69	17.8	0.47	18.7	0.41			
66.0	13.2	1.01	16.9	0.66	19.1	0.46	19.8	0.41	66.0	13.4	1.00	17.0	0.65	19.2	0.46	19.8	0.41			
63.0	14.7	0.92	18.1	0.63	20.1	0.45	20.6	0.41	63.0	14.8	0.92	18.2	0.62	20.2	0.45	20.6	0.41			
60.0	16.0	0.87	19.3	0.61	21.1	0.45			60.0	16.1	0.87	19.4	0.60	21.2	0.45					
55.0	18.2	0.81	21.1	0.58	22.5	0.45			55.0	18.3	0.81	21.2	0.57	22.6	0.44					
50.0	20.3	0.77	22.8	0.56	23.8	0.44			50.0	20.3	0.77	22.9	0.56	23.7	0.44					
46.0	21.7	0.74	24.0	0.55	24.7	0.42			46.0	21.7	0.74	24.0	0.55	24.6	0.42					
40.0	23.7	0.70	25.6	0.53					40.0	23.7	0.70	25.5	0.53							
35.0	25.2	0.66	26.6	0.53					35.0	25.2	0.66	26.6	0.53							
30.0	26.5	0.63	27.4	0.53					30.0	26.4	0.63	27.4	0.53							
26.0	27.3	0.61	27.9	0.53					26.0	27.3	0.61	27.9	0.53							
20.0	28.3	0.58							20.0	28.3	0.58									
15.0	28.9	0.57							15.0	28.8	0.57									
6.0	29.2	0.55							6.0	29.2	0.55									
 ブーム2 (%)	100								ブーム2 (%)	0										
	 ブーム3 (%)	100								ブーム3 (%)	0									
		 ブーム4 (%)	0								ブーム4 (%)	66								
			 ブーム5 (%)	0								ブーム5 (%)	66							
				 ブーム6 (%)	0								ブーム6 (%)	66						
		MODE	A								MODE	B								
 危険角度 [°]	5		25		45		62		[°]	5		25		45		62				
 標準フック [ton]	4.5								[ton]	4.5										
 フック質量 kg	70								kg	70										
 巻掛本数 [本]	1								[本]	1										











ブーム 	ジブ  14.0m	アウトリガ  6.8m	作業範囲 
--	---	--	---

 [m]	32.5							
	5		25		45		60	
 [°]								
	(m)	(ton)	(m)	(ton)	(m)	(ton)	(m)	(ton)
84.0	6.4	1.35	11.1	0.85	14.4	0.50	16.1	0.40
80.0	10.1	1.35	14.4	0.76	17.4	0.48	18.8	0.40
76.0	13.5	1.35	17.5	0.69	20.3	0.46	21.3	0.39
72.0	16.9	1.18	20.5	0.65	22.8	0.45	23.6	0.39
70.0	18.5	1.07	21.9	0.63	24.1	0.44	24.7	0.39
66.0	21.4	0.92	24.6	0.59	26.5	0.43	26.9	0.39
64.0	22.8	0.88	25.9	0.58	27.7	0.43	27.9	0.39
60.0	25.6	0.82	28.4	0.55	29.8	0.43		
55.0	29.3	0.71	31.3	0.53	32.2	0.43		
50.0	31.6	0.45	33.7	0.43	34.3	0.43		
47.0	32.9	0.32	34.9	0.31	35.5	0.31		
	ブーム2 (%)	100						
	ブーム3 (%)	100						
	ブーム4 (%)	100						
	ブーム5 (%)	100						
	ブーム6 (%)	100						
	MODE	A,B						
	危険角度 [°]	46	46	46	46	46	46	63
標準フック [ton]	4.5							
フック質量 kg	70							
巻掛本数 [本]	1							





















 ブーム	 ジブ 14.0m	 アウトリガ 6.3m	 作業範囲
--	---	--	---

 [m]	17.5								17.5									
	5		25		45		60		[°]	5		25		45		60		
	 (m)	 (ton)	 (m)	 (ton)	 (m)	 (ton)	 (m)	 (ton)		 (m)	 (ton)	 (m)	 (ton)	 (m)	 (ton)			
84.0	3.5	1.35	8.3	0.93	11.8	0.55	13.7	0.43	84.0	3.7	1.35	8.5	0.91	12.0	0.53	13.8	0.43	
80.0	5.9	1.35	10.4	0.86	13.6	0.52	15.2	0.42	80.0	6.1	1.35	10.5	0.83	13.8	0.51	15.3	0.42	
75.0	8.6	1.35	12.8	0.77	15.8	0.49	17.0	0.41	75.0	8.9	1.33	13.0	0.75	15.9	0.49	17.1	0.41	
70.0	11.2	1.20	15.1	0.70	17.7	0.47	18.7	0.41	70.0	11.5	1.18	15.3	0.69	17.8	0.47	18.7	0.41	
66.0	13.2	1.01	16.9	0.66	19.1	0.46	19.8	0.41	66.0	13.4	1.00	17.0	0.65	19.2	0.46	19.8	0.41	
63.0	14.7	0.92	18.1	0.63	20.1	0.45	20.6	0.41	63.0	14.8	0.92	18.2	0.62	20.2	0.45	20.6	0.41	
60.0	16.0	0.87	19.3	0.61	21.1	0.45			60.0	16.1	0.87	19.4	0.60	21.2	0.45			
55.0	18.2	0.81	21.1	0.58	22.5	0.45			55.0	18.3	0.81	21.2	0.57	22.6	0.44			
50.0	20.3	0.77	22.8	0.56	23.8	0.44			50.0	20.3	0.77	22.9	0.56	23.7	0.44			
46.0	21.7	0.74	24.0	0.55	24.7	0.42			46.0	21.7	0.74	24.0	0.55	24.6	0.42			
40.0	23.7	0.70	25.6	0.53					40.0	23.7	0.70	25.5	0.53					
35.0	25.2	0.66	26.6	0.53					35.0	25.2	0.66	26.6	0.53					
30.0	26.5	0.63	27.4	0.53					30.0	26.4	0.63	27.4	0.53					
26.0	27.3	0.61	27.9	0.53					26.0	27.3	0.61	27.9	0.53					
20.0	28.3	0.49							20.0	28.3	0.58							
15.0	28.9	0.42							15.0	28.8	0.57							
6.0	29.2	0.38							6.0	29.2	0.55							
	ブーム2 (%)	100								ブーム2 (%)	0							
	ブーム3 (%)	100								ブーム3 (%)	0							
	ブーム4 (%)	0								ブーム4 (%)	66							
	ブーム5 (%)	0								ブーム5 (%)	66							
	ブーム6 (%)	0								ブーム6 (%)	66							
	MODE	A								MODE	B							
 危険角度 [°]	5	25		45		62		[°]	5	25		45		62				
 標準フック [ton]	4.5								[ton]	4.5								
 フック質量 kg	70								kg	70								
 巻掛本数 [本]	1								[本]	1								















ブーム 	ジブ  14.0m	アウトリガ  6.3m	作業範囲 
--	---	--	---

 [m]	32.5							
	5		25		45		60	
 [°]								
	 [°]	 (m) (ton)	 (m) (ton)	 (m) (ton)	 (m) (ton)	 (m) (ton)	 (m) (ton)	 (m) (ton)
84.0	6.4	1.35	11.1	0.85	14.4	0.50	16.1	0.40
80.0	10.1	1.35	14.4	0.76	17.4	0.48	18.8	0.40
76.0	13.5	1.35	17.5	0.69	20.3	0.46	21.3	0.39
72.0	16.9	1.18	20.5	0.65	22.8	0.45	23.6	0.39
70.0	18.5	1.07	21.9	0.63	24.1	0.44	24.7	0.39
66.0	21.4	0.92	24.6	0.59	26.5	0.43	26.9	0.39
64.0	22.8	0.88	25.9	0.58	27.7	0.43	27.9	0.39
60.0	25.6	0.82	28.4	0.55	29.8	0.43		
55.0	28.6	0.57	31.3	0.51	32.2	0.43		
52.0	30.1	0.40	32.6	0.36	33.5	0.36		
51.0	30.7	0.34						
	ブーム2 (%)	100						
	ブーム3 (%)	100						
	ブーム4 (%)	100						
	ブーム5 (%)	100						
	ブーム6 (%)	100						
	MODE	A,B						
	危険角度 [°]	50	51	51	51	63		
標準フック [ton]	4.5							
フック質量 kg	70							
巻掛本数 [本]	1							



















 ブーム	 ジブ 14.0m	 アウトリガ 5.2m	 作業範囲
--	---	--	---

 [m]	17.5								17.5									
	5		25		45		60		[°]	5		25		45		60		
	 (m)	 (ton)	 (m)	 (ton)	 (m)	 (ton)	 (m)	 (ton)		 (m)	 (ton)	 (m)	 (ton)	 (m)	 (ton)	 (m)	 (ton)	
84.0	3.5	1.35	8.3	0.93	11.8	0.55	13.7	0.43	84.0	3.7	1.35	8.5	0.91	12.0	0.53	13.8	0.43	
80.0	5.9	1.35	10.4	0.86	13.6	0.52	15.2	0.42	80.0	6.1	1.35	10.5	0.83	13.8	0.51	15.3	0.42	
75.0	8.6	1.35	12.8	0.77	15.8	0.49	17.0	0.41	75.0	8.9	1.33	13.0	0.75	15.9	0.49	17.1	0.41	
70.0	11.2	1.20	15.1	0.70	17.7	0.47	18.7	0.41	70.0	11.5	1.18	15.3	0.69	17.8	0.47	18.7	0.41	
66.0	13.2	1.01	16.9	0.66	19.1	0.46	19.8	0.41	66.0	13.4	1.00	17.0	0.65	19.2	0.46	19.8	0.41	
63.0	14.7	0.92	18.1	0.63	20.1	0.45	20.6	0.41	63.0	14.8	0.92	18.2	0.62	20.2	0.45	20.6	0.41	
60.0	16.0	0.87	19.3	0.61	21.1	0.45			60.0	16.1	0.87	19.4	0.60	21.2	0.45			
55.0	18.2	0.81	21.1	0.58	22.5	0.45			55.0	18.3	0.81	21.2	0.57	22.6	0.44			
50.0	20.3	0.77	22.8	0.56	23.8	0.44			50.0	20.3	0.77	22.9	0.56	23.7	0.44			
46.0	21.7	0.74	24.0	0.55	24.7	0.42			46.0	21.7	0.74	24.0	0.55	24.6	0.42			
40.0	23.7	0.57	25.5	0.53					40.0	23.7	0.70	25.5	0.53					
34.0	25.4	0.34	26.8	0.34					35.0	25.2	0.66	26.6	0.53					
33.0	25.6	0.31							34.0	25.5	0.65	26.8	0.53					
									33.0	25.7	0.64	26.9	0.53					
									30.0	26.4	0.63	27.4	0.53					
									26.0	27.3	0.61	27.9	0.53					
									20.0	28.3	0.58							
									15.0	28.8	0.57							
									6.0	29.2	0.55							
 ブーム2 (%)	100								ブーム2 (%)	0								
	 危険角度	100								ブーム3 (%)	0							
		0								ブーム4 (%)	66							
		0								ブーム5 (%)	66							
		0								ブーム6 (%)	66							
		A								MODE	B							
 標準フック	4.5								[ton]	4.5								
	70								kg	70								
	1								[本]	1								

















 ブーム	 ジブ 14.0m	 アウトリガ 5.2m	 作業範囲
---	--	---	--

 [m]	32.5								
	5		25		45		60		
 [°]									
	 (m)	 (ton)	 (m)	 (ton)	 (m)	 (ton)	 (m)	 (ton)	
84.0	6.4	1.35	11.1	0.85	14.4	0.50	16.1	0.40	
80.0	10.1	1.35	14.4	0.76	17.4	0.48	18.8	0.40	
76.0	13.5	1.35	17.5	0.69	20.3	0.46	21.3	0.39	
72.0	16.9	1.18	20.5	0.65	22.8	0.45	23.6	0.39	
70.0	18.5	1.07	21.9	0.63	24.1	0.44	24.7	0.39	
66.0	21.4	0.92	24.6	0.59	26.5	0.43	26.9	0.39	
64.0	22.8	0.80	25.9	0.58	27.7	0.43	27.9	0.39	
62.0	24.3	0.58	27.1	0.52	28.7	0.43			
61.0	24.4	0.56							
	ブーム2 (%)	100							
	ブーム3 (%)	100							
	ブーム4 (%)	100							
	ブーム5 (%)	100							
	ブーム6 (%)	100							
	MODE	A,B							
	 危険角度 [°]	60		61		61		63	
 標準フック [ton]	4.5								
 フック質量 kg	70								
 巻掛本数 [本]	1								

 ブーム	 ジブ 14.0m	 アウトリガ 4.2m	 作業範囲
--	---	--	---



 [m]	17.5								17.5									
	5		25		45		60		[°]	5		25		45		60		
	 [°]	 (m)	 (ton)	 (m)	 (ton)	 (m)	 (ton)	 (m)		 (ton)	 (m)	 (ton)	 (m)	 (ton)				
84.0	3.5	1.35	8.3	0.93	11.8	0.55	13.7	0.43	84.0	3.7	1.35	8.5	0.91	12.0	0.53	13.8	0.43	
80.0	5.9	1.35	10.4	0.86	13.6	0.52	15.2	0.42	80.0	6.1	1.35	10.5	0.83	13.8	0.51	15.3	0.42	
75.0	8.6	1.35	12.8	0.77	15.8	0.49	17.0	0.41	75.0	8.9	1.33	13.0	0.75	15.9	0.49	17.1	0.41	
70.0	11.2	1.20	15.1	0.70	17.7	0.47	18.7	0.41	70.0	11.5	1.18	15.3	0.69	17.8	0.47	18.7	0.41	
66.0	13.2	1.01	16.9	0.66	19.1	0.46	19.8	0.41	66.0	13.4	1.00	17.0	0.65	19.2	0.46	19.8	0.41	
63.0	14.7	0.92	18.1	0.63	20.1	0.45	20.6	0.41	63.0	14.8	0.92	18.2	0.62	20.2	0.45	20.6	0.41	
60.0	16.0	0.87	19.3	0.61	21.1	0.45			60.0	16.1	0.87	19.4	0.60	21.2	0.45			
55.0	18.2	0.81	21.1	0.58	22.5	0.45			55.0	18.3	0.81	21.2	0.57	22.6	0.44			
50.0	20.2	0.56	22.8	0.47	23.8	0.44			50.0	20.3	0.77	22.9	0.56	23.7	0.44			
47.0	21.2	0.39	23.6	0.34	24.5	0.34			47.0	21.4	0.75	23.7	0.55	24.4	0.43			
46.0	21.6	0.34							46.0	21.7	0.74	24.0	0.55	24.6	0.42			
									40.0	23.7	0.70	25.5	0.53					
									35.0	25.2	0.66	26.6	0.53					
									30.0	26.4	0.55	27.4	0.53					
									26.0	27.3	0.47	27.9	0.47					
									20.0	28.3	0.39							
									15.0	28.8	0.35							
									6.0	29.2	0.32							
 ブーム2 (%)	100								ブーム2 (%)	0								
	 標準フック	100								ブーム3 (%)	0							
		0								ブーム4 (%)	66							
		0								ブーム5 (%)	66							
		0								ブーム6 (%)	66							
		A								MODE	B							
 危険角度	45		46		46		62		[°]	5		25		45		62		
 フック質量	70								kg	70								
 巻掛本数	1								[本]	1								







ブーム 	ジブ  14.0m	アウトリガ  4.2m	作業範囲 
--	---	--	---

 [m]	32.5							
	5		25		45		60	
 [°]								
 [°]								
	(m)	(ton)	(m)	(ton)	(m)	(ton)	(m)	(ton)
84.0	6.4	1.35	11.1	0.85	14.4	0.50	16.1	0.40
80.0	10.1	1.35	14.4	0.76	17.4	0.48	18.8	0.40
76.0	13.5	1.35	17.5	0.69	20.3	0.46	21.3	0.39
72.0	16.9	1.18	20.5	0.65	22.8	0.45	23.6	0.39
70.0	18.5	0.97	21.9	0.63	24.1	0.44	24.7	0.39
	ブーム2 (%)	100						
	ブーム3 (%)	100						
	ブーム4 (%)	100						
	ブーム5 (%)	100						
	ブーム6 (%)	100						
	MODE	A,B						
 [°]	69		69		69		69	
 [ton]	4.5							
 kg	70							
 [本]	1							

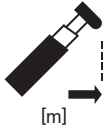
KATO MR-350RfII

ブーム【定置つり】 定格総荷重表



ブーム 	ジブ	アウトリガ 	作業範囲
---	----	---	------







[m]	作業範囲	7.5		12.5				17.5				22.5			
		↑	⌚	↑	⌚	↑	⌚	↑	⌚	↑	⌚	↑	⌚	↑	⌚
	2.6	13.00	8.20	12.00	6.50	12.00	6.50	8.00	6.50	8.00	6.50				
	3.0	13.00	8.20	12.00	6.50	12.00	6.50	8.00	6.50	8.00	6.50	6.50	5.00	6.50	5.00
	3.5	11.50	5.40	11.00	5.20	11.00	5.20	8.00	5.20	8.00	5.20	6.50	5.00	6.50	5.00
	4.0	10.00	4.20	9.60	4.00	9.60	4.00	8.00	4.00	8.00	4.00	6.50	5.00	6.50	5.00
	4.5	8.50	3.20	8.10	3.20	8.10	3.20	7.70	3.10	7.70	3.10	6.50	3.80	6.50	3.80
	5.0	7.00	2.30	6.80	2.50	6.80	2.50	6.80	2.40	6.80	2.40	6.50	2.90	6.50	2.90
	5.5			5.70	1.90	5.70	1.90	5.80	1.80	5.80	1.80	5.75	2.25	5.75	2.25
	6.0			4.60	1.30	4.60	1.30	4.80	1.20	4.80	1.20	4.85	1.75	4.85	1.75
	6.5			3.65	0.80	3.65	0.80	3.95	0.75	3.95	0.75	4.15	1.30	4.15	1.30
	7.0			2.95	0.50	2.95	0.50	3.10	0.50	3.10	0.50	3.60	0.95	3.60	0.95
	8.0			2.05		2.05		1.80		1.80		2.65	0.50	2.65	0.50
	9.0			1.40		1.40		1.10		1.10		1.80		1.80	
	10.0			0.80		0.80		0.70		0.70		1.20		1.20	
11.0							0.50		0.50		0.80		0.80		
12.0											0.60		0.60		
	ブーム2 (%)	0		50		0		100		0		100		0	
	ブーム3 (%)	0		50		0		100		0		100		0	
	ブーム4 (%)	0		0		33		0		66		33		100	
	ブーム5 (%)	0		0		33		0		66		33		100	
	ブーム6 (%)	0		0		33		0		66		33		100	
	MODE		A,B		A		B		A		B		A		B
 危険角度	[°]	-	-	-	44	-	44	42	59	42	59	51	63	51	63
 標準フック	[ton]	22													
 フック質量	[kg]	225													
 巻掛本数	[本]	4													

(単位 : ton)

KATO 06A-74505A00

ブーム【走行つり】 定格総荷重表

ブーム 	ジブ	アウトリガ 	作業範囲
---	----	---	------

[m]	作業範囲	7.5		12.5				17.5				22.5			
		↑	⌚	↑	⌚	↑	⌚	↑	⌚	↑	⌚	↑	⌚	↑	⌚
	2.6	9.50	6.00	9.50	5.50	9.50	5.50	7.00	5.50	7.00	5.50				
	3.0	9.50	6.00	9.50	5.50	9.50	5.50	7.00	5.50	7.00	5.50	6.00	4.50	6.00	4.50
	3.5	8.50	4.50	8.60	4.40	8.60	4.40	7.00	4.40	7.00	4.40	6.00	4.50	6.00	4.50
	4.0	7.50	3.55	7.50	3.55	7.50	3.55	7.00	3.55	7.00	3.55	6.00	3.90	6.00	3.90
	4.5	6.60	2.85	6.60	2.85	6.60	2.85	6.40	2.85	6.40	2.85	6.00	3.40	6.00	3.40
	5.0	5.80	2.30	5.80	2.25	5.80	2.25	5.80	2.25	5.80	2.25	5.60	2.90	5.60	2.90
	5.5			5.00	1.75	5.00	1.75	5.20	1.75	5.20	1.75	5.20	2.25	5.20	2.25
	6.0			4.20	1.30	4.20	1.30	4.60	1.20	4.60	1.20	4.70	1.75	4.70	1.75
	6.5			3.55	0.80	3.55	0.80	3.90	0.75	3.90	0.75	4.15	1.30	4.15	1.30
	7.0			2.80		2.80		3.10		3.10		3.60	0.95	3.60	0.95
	8.0			1.95		1.95		1.80		1.80		2.65		2.65	
	9.0			1.40		1.40		1.10		1.10		1.80		1.80	
	10.0			0.80		0.80		0.70		0.70		1.20		1.20	
11.0							0.50		0.50		0.80		0.80		
12.0											0.60		0.60		
	ブーム2 (%)	0		50		0		100		0		100		0	
	ブーム3 (%)	0		50		0		100		0		100		0	
	ブーム4 (%)	0		0		33		0		66		33		100	
	ブーム5 (%)	0		0		33		0		66		33		100	
	ブーム6 (%)	0		0		33		0		66		33		100	
	MODE		A,B		A		B		A		B		A		B
 危険角度	[°]	-	-	-	48	-	48	42	61	42	61	51	66	51	66
 標準フック	[ton]	22													
 フック質量	[kg]	225													
 巻掛本数	[本]	4													

(単位 : ton)

KATO 06A-74506A00

■ 作業範囲図

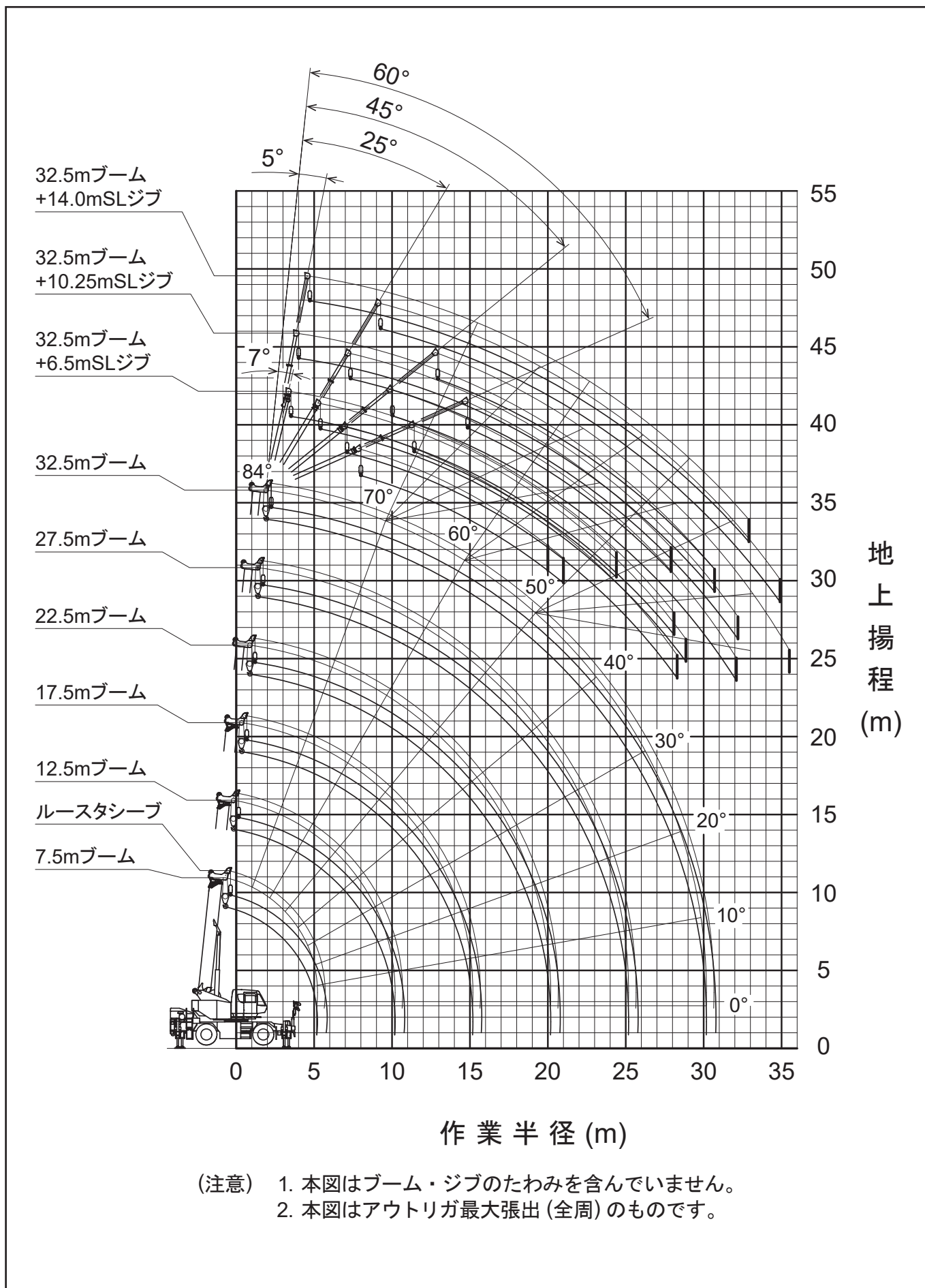

最小通路軌跡図

● 60°

2輪ステアリングで右折する場合

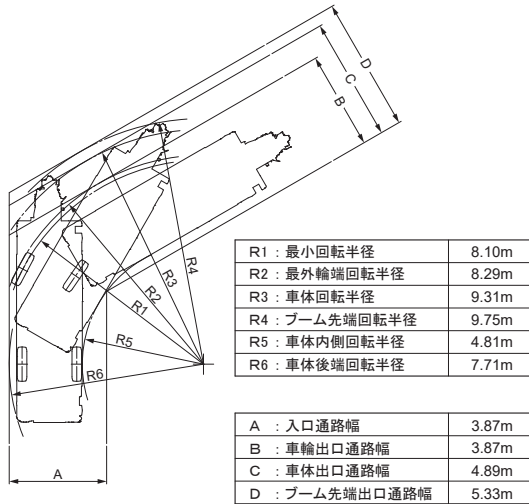

4輪ステアリングで右折する場合(構内移動)

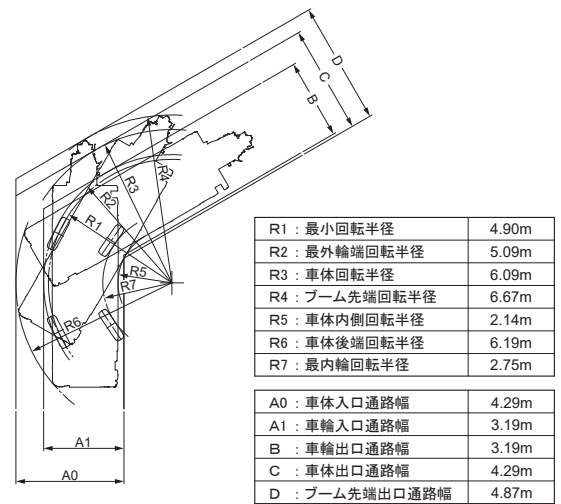

● 90°

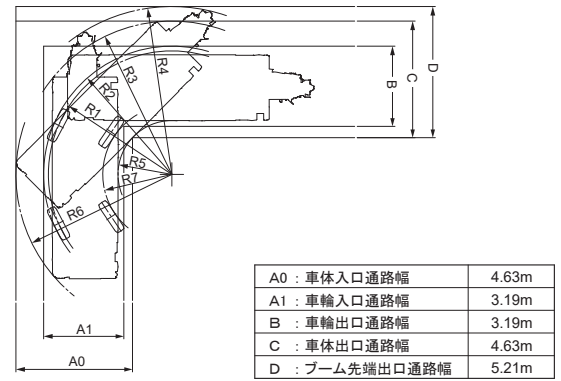
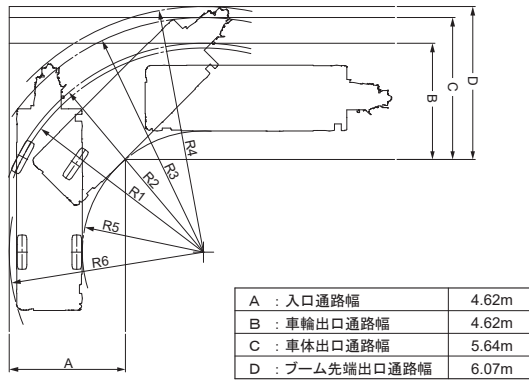

● 120°

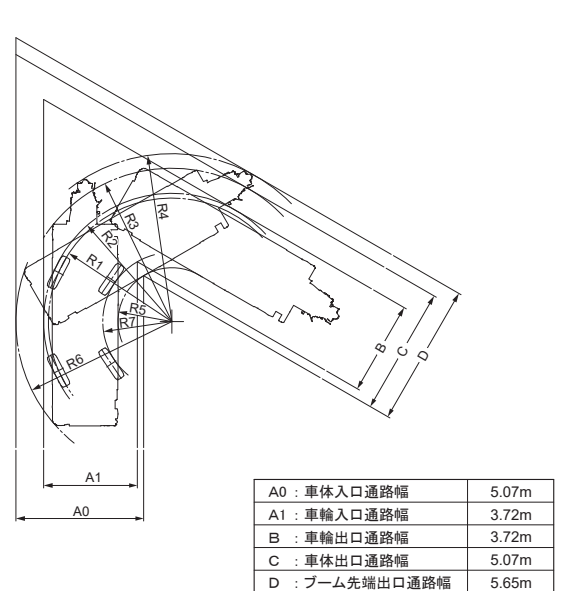
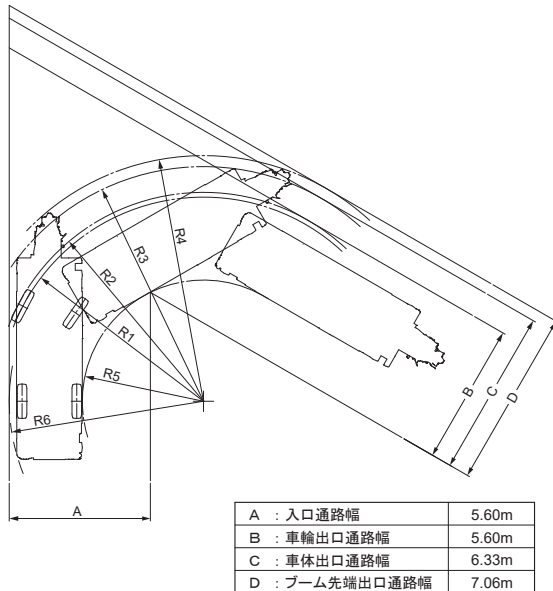

縮尺: $\frac{1}{300}$ 単位 (注) 上記の数値は計算値です。

■ 全体図

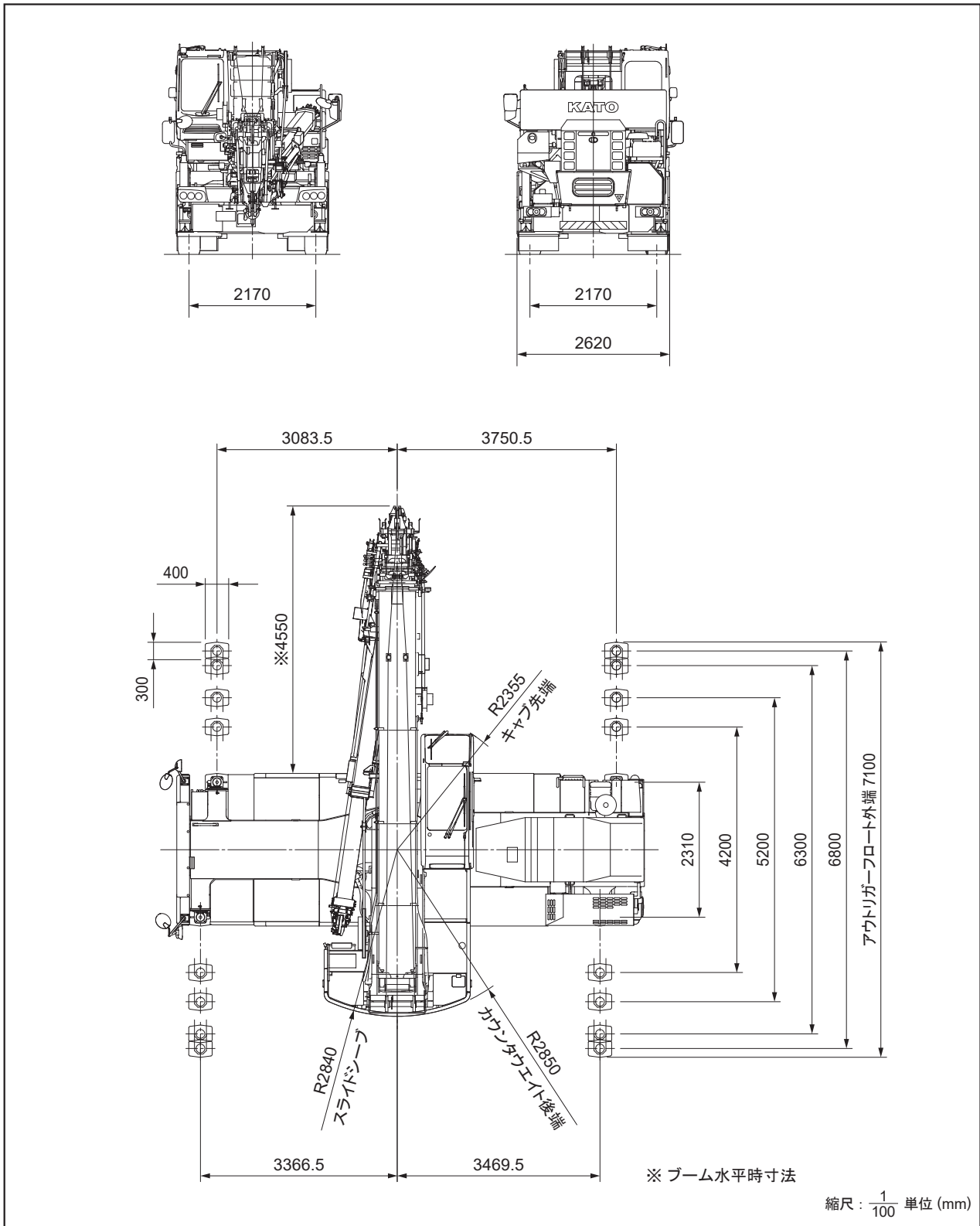

全体図

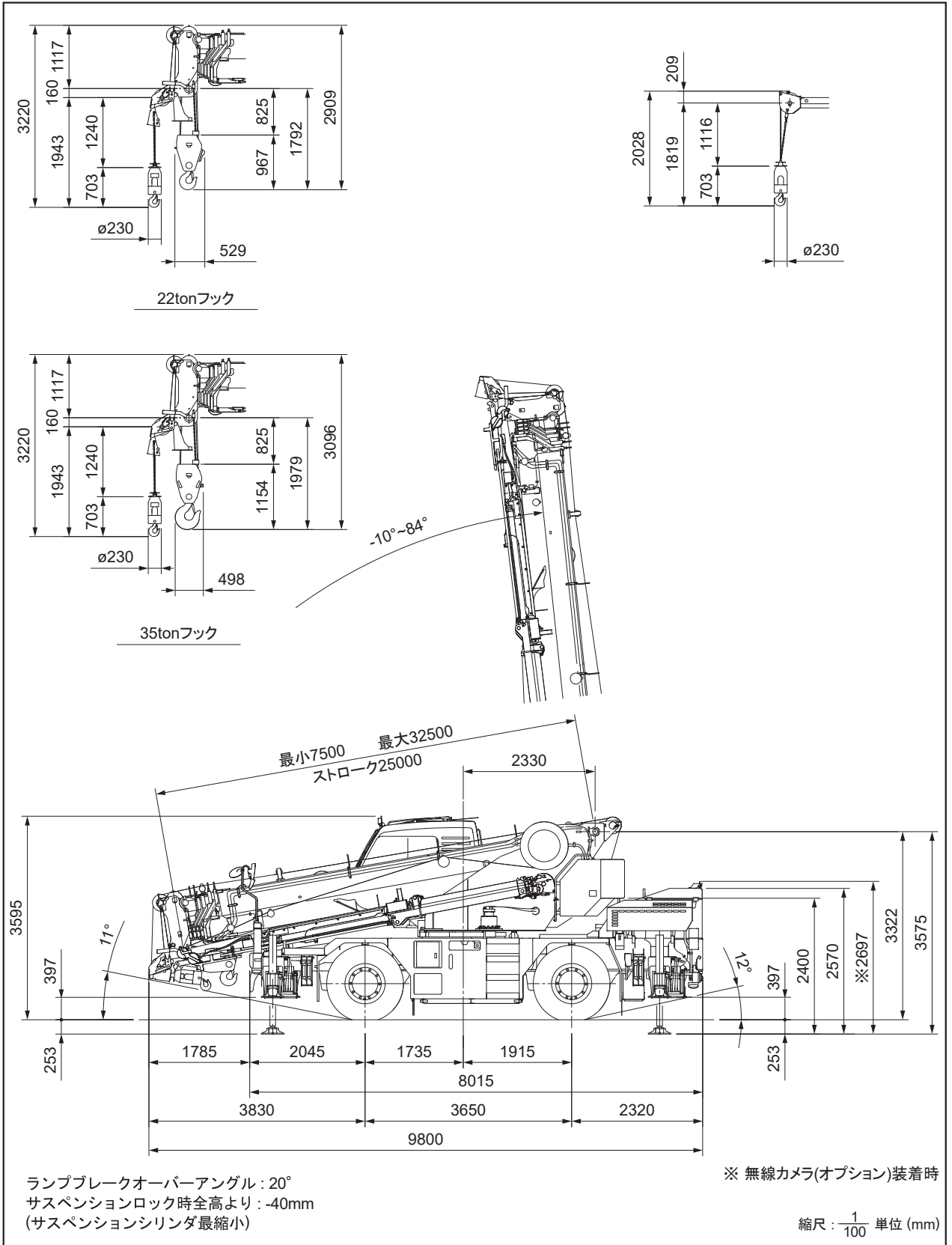

I219691-122-0J

※本カタログに記載されております性能ならびに仕様は、改良などによりお届けいたします製品と異なる場合がありますので、あらかじめご了承ください。

お問い合わせは…

KATO 株式会社 **加藤製作所**

本 社 / 〒140-0011 東京都品川区東大井1丁目9番37号

☎ 03 (3458) 1111番 (大代表)

ホームページアドレス <http://www.kato-works.co.jp>

C05742

9.2022-1000 (TI) 2