

目次

主要諸元	2
定格総荷重表注意事項	3
作業範囲図	4
定格総荷重表	
ブーム【MODE A(通常伸縮)・MODE B(特殊伸縮)】	5
ブーム+SLジブ	12
ブーム【定置つり】	48
ブーム【走行つり】	49
最小通路軌跡図	50
全体図	51
全体図	52

■主要諸元

■クレーン部

名称	60ton吊りラフテレーンクレーン
型式	KR-60H-F

●クレーン性能

最大定格総荷重	10.1 mブーム	60,000kg× 1.8m (13本掛)
	17.6 mブーム	30,000kg× 4.5m (7本掛)
	25.1 mブーム	15,000kg× 8.5m (6本掛)
	32.5 mブーム	12,500kg× 9.0m (4本掛)
	36.5 mブーム	9,000kg× 11.0m (4本掛)
	40.0 mブーム	7,500kg× 11.0m (4本掛)
	8.92 mジブ	4,200kg× 72° (1本掛)
	12.7 mジブ	2,800kg× 80° (1本掛)
	16.5 mジブ	2,000kg× 80° (1本掛)
ルースタシーブ	5,600kg (1本掛)	

ブーム長さ	10.1m ~ 40.0m
ジブ長さ	8.92m ~ 16.5m
最大地上揚程	41.1m (ブーム) 57.5m (ジブ)

巻上ロープ速度	主巻	135m / min (5層目)
	補巻	128m / min (4層目)
巻上フック速度	主フック	(ロープ掛数 13) 10.3m / min (5層目)
	補フック	(ロープ掛数 1) 128.0m / min (4層目)
ブーム起伏範囲	0° ~ 84°	
ブーム上げ時間	49s / 0° ~ 84°	
ブーム伸長速度	29.9m / 97s	
旋回速度	2.0min ⁻¹	
旋回後端半径	3,550mm	

●上部旋回体の装置および構造

ブーム形式	箱型5段油圧伸縮式 (3・4・5段同時)	
ジブ形式	箱型3段油圧伸縮式 (2・3段同時) 油圧無段階傾斜式 (オフセット5° ~ 60°)	
ブーム伸縮装置	油圧シリンダー (2本) およびワイヤロープ併用	
ブーム起伏装置	油圧シリンダー直押式 (1本)、圧力補償付流量調整弁付	
ジブ伸縮装置	油圧シリンダー (1本) およびワイヤロープ併用	
ジブ起伏装置	油圧シリンダー (2本)	
巻上装置	シングルウインチ2基、油圧モータ駆動・遊星歯車減速式 (ネガティブブレーキ内蔵) 自動ブレーキ付、圧力補償付流量調整弁付	
旋回装置	油圧モータ駆動・遊星歯車減速機付 (ネガティブブレーキ内蔵) ブリー・ロック切換式、高低速切換式	
旋回サークル	ボールベアリング式	
アウトリガ装置	形式	全油圧H型 (フロント、バーチカルシリンダー一体型)
	張出幅	7,600mm (最大張出)
		7,200mm (中間張出)
		6,500mm (中間張出)
		5,400mm (中間張出)
		4,300mm (中間張出)
2,430mm (最小張出)		
ワイヤロープ	主巻	難自転性ワイヤロープ φ18 × 217m
	補巻	難自転性ワイヤロープ φ18 × 123m

●油圧装置

油圧ポンプ	2重可変プランジャ型、可変プランジャ型+プランジャ型	
油圧モータ	巻上用	アキシャルプランジャ型
	旋回用	アキシャルプランジャ型
コントロールバルブ	マルチプル自動復元式 (圧力補償付流量調整弁付)	
シリンダー	ダブルアクティング式	
オイルリザーバ容量	740L	

●安全装置

ACS (過負荷防止装置・音声警報装置付)、旋回自動停止装置、ブーム起伏緩停止装置、ブーム伸長緩停止装置、作業範囲制限装置、アウトリガ張出幅自動検出装置、ブーム起伏自然降下防止装置、ブーム伸縮自然降下防止装置、ジブ起伏自然降下防止装置、ジブ伸縮自然降下防止装置、過巻防止装置、ドラムホールド安全装置、自動ブレーキ装置、乱巻防止装置、油圧安全弁、アウトリガロック装置、旋回ロック装置、旋回警告灯、作動油オーバーヒート警報装置、作動油フィルタ目詰まり警報装置、玉掛ロープはずれ止め
--

●標準装置

ドラム回転指示装置、オイルクーラ、ウインチ確認カメラ、ACS外部表示装置、ACS外部音声警報装置、拡声器、リモコンサーチライト、LED作業灯 (ブーム、テーブル、キャブ)

●キャブ装備

除霜機能付エアコン、LEDルームランプ、液封式キャブマウント、チルト/テレスコピックハンドル、フルアジャスタブル・サスペンションシート (ヘッドレスト、アームレスト付)、パワーウィンドウ (閉め忘れ防止スイッチ付)、窓穴付フロント&ルーフワイパー (ウォッシャー付)、Bluetooth付AM/FMラジオ、LEDステップランプ、フロアマット、アクセサリーソケット (24V)、USB電源装置、デジタルタコグラフ、エントリーキーシステム、クレーン作業記録装置、電子水準器 (自動アウトリガ水平補助機能付)・AUXポート
--

●オプション装置

カメラクリーナ (ウインチ確認カメラ用) (注1)、無線式吊钩監視カメラ用電源供給システム、燃焼式エアヒーター、ドアヒーター、風速計、消火器、大型ランチテーブル、ハンズフリーマイク、キャブステークガード、アッシュトレイ (注1) 左前方確認カメラ・左後方確認カメラ・右後方確認カメラ及び12.1インチタッチモニタ (人検知支援機能付)、セーフティビューシステム 後進時のみ装着可。カメラクリーナ (セーフティビューカメラ用)、カメラクリーナ (左方確認カメラ、右方確認カメラ用) と同時装着。
--

●Bluetooth®はBluetooth SIG, Inc.の登録商標です。

■キャリア部

●走行性能

最高速度	49km / h
登坂能力	0.60 (tanθ)
最小回転半径	10.8m (2輪操向)
	6.7m (6輪操向)

●エンジン

エンジン名称	Daimler OM936LA (インタークーラターボ付) (平成26年ディーゼル特殊自動車排出ガス規制適合)
エンジン形式	水冷4サイクル6気筒 直接噴射式ディーゼルエンジン
総排気量	7.697L
最大出力	254kW / 2,000min ⁻¹
最大トルク	1,400N・m / 1,200-1,600min ⁻¹

●下部走行体の装置および構造

走行駆動形式	2輪駆動 (6×2)・4輪駆動 (6×4) 切換式	
トルクコンバータ形式	3要素 1段 (自動ロックアップクラッチ付)	
変速機形式	全自動および手動変速式	
変速段数	前進6段 後退2段	
車軸形式	前輪	全浮動軸管式逆エリオット形 (ドライブステア、減速機付)
	後前輪	逆エリオット形 (ステア)
	後後輪	全浮動軸管式逆エリオット形 (ドライブステア、減速機、テフロック付)
懸架装置	前輪	ハイドロニューマチックサスペンション (油圧ロックシリンダー付)
	後前輪	ハイドロニューマチックサスペンション (油圧ロックシリンダー付)
	後後輪	ハイドロニューマチックサスペンション (油圧ロックシリンダー付)
ブレーキ装置	主	2系統空気油圧複合式全輪制動
	補助	空気式・推進軸制動内部拡張形 圧縮空気開放式エンジンブレーキ (電子制御によるトルクコントロール同時制御方式) 永久磁石式リタター、作業用補助制動装置、坂道発進補助装置
ステアリング装置	形式	全油圧式パワーステアリング
	モード	前2輪、カウンタ、クラス、後4輪、前後輪独立 (5モード) (リヤステ自動ロック機構付)
タイヤサイズ	前輪	385 / 95 R25 170E ROAD
	後輪	385 / 95 R25 170E ROAD
燃料タンク容量	370L	
尿素水タンク容量	40L	
バッテリー	(12V-150AH) × 2	

●安全装置

緊急用かじり装置、後輪ステアリングロック装置、ブレーキ液漏警報装置、作業用補助制動装置、サスペンションロック装置、オーバールン警報装置、ローエアー警報装置、電動格納サイドミラー、左方確認カメラ、右方確認カメラ、左前方確認カメラ、左後方確認カメラ、前方確認カメラ、右後方確認カメラおよび12.1インチ大型タッチモニタ (人検知支援機能付)、セーフティビューシステム、坂道発進補助装置

●標準装置

フルLEDヘッドランプ (アクセラライト付)、ハイパスフィルター、アルミ敷板、車輪止め、路肩灯、LEDサイドマーカーランプ (アンダーライト付)

●オプション装置

後方確認カメラ及びアインチライト (注2)、クリアランスソナーシステム (左前部、左前輪部、左後部、右後部及び後部換出) (注2)、カメラクリーナ (セーフティビューカメラ用) (注3)、カメラクリーナ (左方確認カメラ、右方確認カメラ用) (注3)、無線式後方確認カメラ (注4)、ヒータ付サイドミラー、ブーム右側ミラー、左折およびバック音声警報装置、タイヤ空気圧モニタリングシステム、アウトリガ操作ラジオ (エンジン非常停止スイッチ付) (注2) 左前方確認カメラ・左後方確認カメラ・右後方確認カメラ及び12.1インチタッチモニタ (人検知支援機能付)、セーフティビューシステムと置き換えて同時装着。(注3) 左前方確認カメラ・左後方確認カメラ・右後方確認カメラ及び12.1インチタッチモニタ (人検知支援機能付)、セーフティビューシステム 装着時のみ装着可。カメラクリーナ (ウインチ確認カメラ用) と同時装着。(注4) 後方確認カメラ及びアインチライト装着時のみ装着可。

■寸法・重量

全長	12,390mm	
全幅	2,750mm	
全高	3,730mm	
軸距	4,250+1,500=5,750mm	
輪距	前輪	2,300mm
	後輪	2,300mm
乗車定員	1人	
車両総重量	全重量	35,895kg
	前軸重	13,995kg
	後前軸重	8,100kg
	後後軸重	13,800kg

●KR-60H-F型は、新規開発車両証明制度による適合証明書「基本通行条件 重量 ; D」の交付を受けていますが、実際の通行条件は、運行経路ごとの道路管理者の算定結果によって付与されます。

■運転および作業に必要な資格

	クレーンの運転	移動式クレーン運転士免許
	玉掛作業	玉掛技能講習
	車両の運転	大型特殊自動車運転免許

- 走行時はフックを所定の位置に格納してください。
- 道路の走行には、道路法による通行の許可と道路運送車両法による保安基準の緩和が必要です。
- 本車両は最低速度 (50km/h) の定めのある「高速自動車国道」を走行することはできません。
- 本機の使用にあたっての注意事項は、取扱説明書をよく読んで正しくお使いください。
- 本カタログに記載されております性能ならびに仕様は、改良などによりお届いたします製品と異なる場合があります。また、仕様は予告なく変更することがありますのであらかじめご了承ください。

■ 定格総荷重表注意事項

● アウトリガ使用時

1. 定格総荷重表は水平堅土上において機体を水平に設置した状態での保証できる最大荷重を示しており、ブーム作業時は主フックとつり具、ジブ作業時は補フックとつり具の質量を含んだ値です。
【60tフック（質量500kg）、34tフック（質量310kg）、5.6tフック（質量120kg）】
□部分は機械の強度によって、他は機体の安定度によって定められています。
2. 作業半径はブーム、SLジブのたわみを含んだ実際の値にもとづいていますので、必ず作業半径を基準として作業を行ってください。
3. ジブの作業半径は25.1m(MODE A、MODE Bでは25.0m)または40.0mブームにジブを装着して作業を行った場合の値です。25.1m(MODE A、MODE Bでは25.0m)をこえ40.0m未満のブーム長さでのジブ作業は、作業半径ではなく40.0mブームの角度を基準としてください。
また、25.1m(MODE A、MODE Bでは25.0m)未満のブーム長さでのジブ作業は、作業半径ではなく25.1m(MODE A、MODE Bでは25.0m)ブームの角度を基準としてください。
4. アウトリガ最縮小張出では、ジブ作業を行わないでください。
5. アウトリガ張出状態によって側方領域でのつり上性能は異なります。従って各々の張出状態における定格総荷重表で作業を行ってください。
また、前方領域でのつり上性能は前方性能の定格総荷重表で、後方領域でのつり上性能はアウトリガ最大張出の定格総荷重表でそれぞれ作業を行ってください。

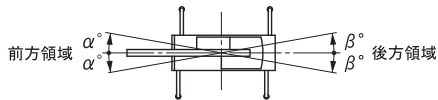

領域 α°		前側アウトリガ張出状態						
		最大張出 7.6m	中間張出				最縮小張出※ 2.43m	
張出状態 アウトリガ	最大張出	7.6m	45	30	25	25	15	3
	中間張出	7.2m						
		6.5m						
		5.4m						
		4.3m						
最縮小張出※	2.43m	35						

アウトリガ張出状態	中間張出				最縮小張出※
	7.2m	6.5m	5.4m	4.3m	2.43m
領域 β°	30	25	25	15	3

※SLジブ作業時は作業できません。

6. ルースタシーブの定格総荷重は、ブームの定格総荷重よりブームに取付けられているフックその他のつり具の質量を差し引いた値とし、かつ限度はブーム長さおよびブーム伸縮モードにより異なります。

【ルースタシーブ使用フック:5.6tフック(質量120kg)巻掛本数1】

	10.1mブーム	17.6mブーム	25.0mブーム 25.1mブーム	32.5mブーム	36.5mブーム	40.0mブーム
MODE A	5.6t	5.6t	5.6t	5.6t	5.3t	5.0t
MODE B				5.0t	5.0t	

7. ブーム長さ、ブーム角度、作業半径、ジブ長さ、およびジブ角度が規定の値をこえる場合にはその規定の値と、次の規定の値の定格総荷重のうち小さい方の定格総荷重を目安として作業を行ってください。
8. ジブを装着したままでブーム作業を行う場合の定格総荷重は、ブームの定格総荷重よりフックその他のつり具等の質量の他に4,000kgを差し引いた値とし、かつ上限を18tとします。なおジブを装着したままのルースタ作業、およびアウトリガ最縮小張出におけるジブを装着したままのブーム作業は行わないでください。

【ジブ装着時使用主フック:34tフック(質量310kg)】

9. 各々の作業状態におけるブーム危険角度は表のとおりです。ブームを危険角度以下にしますと無負荷でも転倒しますので充分注意してください。
10. 各ブーム長さに対する標準フック巻掛本数は表のとおりです。ただし標準巻掛本数以外の掛数で使用する場合は、ワイヤロープ1本当たり45.1kN(4.6tf)を限度としてください。
11. フック巻掛本数13本で作業を行う場合はルースタシーブおよびシーブブロックを使用してください。
12. 高速巻下作業は、フックのみを降下するときに使用してください。また急激なレバー操作はさけてください。
13. クレーン作業は風速10m/sまで可能ですが、比較的弱い風の場合でも受風面積の大きい荷重を取扱う場合は特別な注意を払ってください。
14. 定格総荷重をこえる作業を行った場合、および正しい使い方を行わなかった場合は転倒または破損します。
この場合本機の保証はいたしません。

● アウトリガ不使用時

1. 定格総荷重表は、水平堅土上においてタイヤの空気圧が規定圧で、かつサスペンションシリンダを「レベルロック」した場合に本機の保証できる最大荷重を示しており、主フックとつり具の質量を含んだ値です。
□部分は機械の強度によって、他は機体の安定度によって定められています。
【タイヤ規定空気圧:900kPa】
2. 作業半径はブームのたわみを含んだ実際の値にもとづいていますので、必ず作業半径を基準として作業を行ってください。
3. 前方性能と全周性能とは定格総荷重が異なります。前方領域から側方領域へ旋回する場合には過荷重になるおそれがありますので充分注意してください。

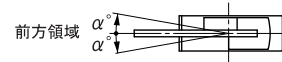

クレーン作業 領域 α°	定置つり	走行つり
	1	1





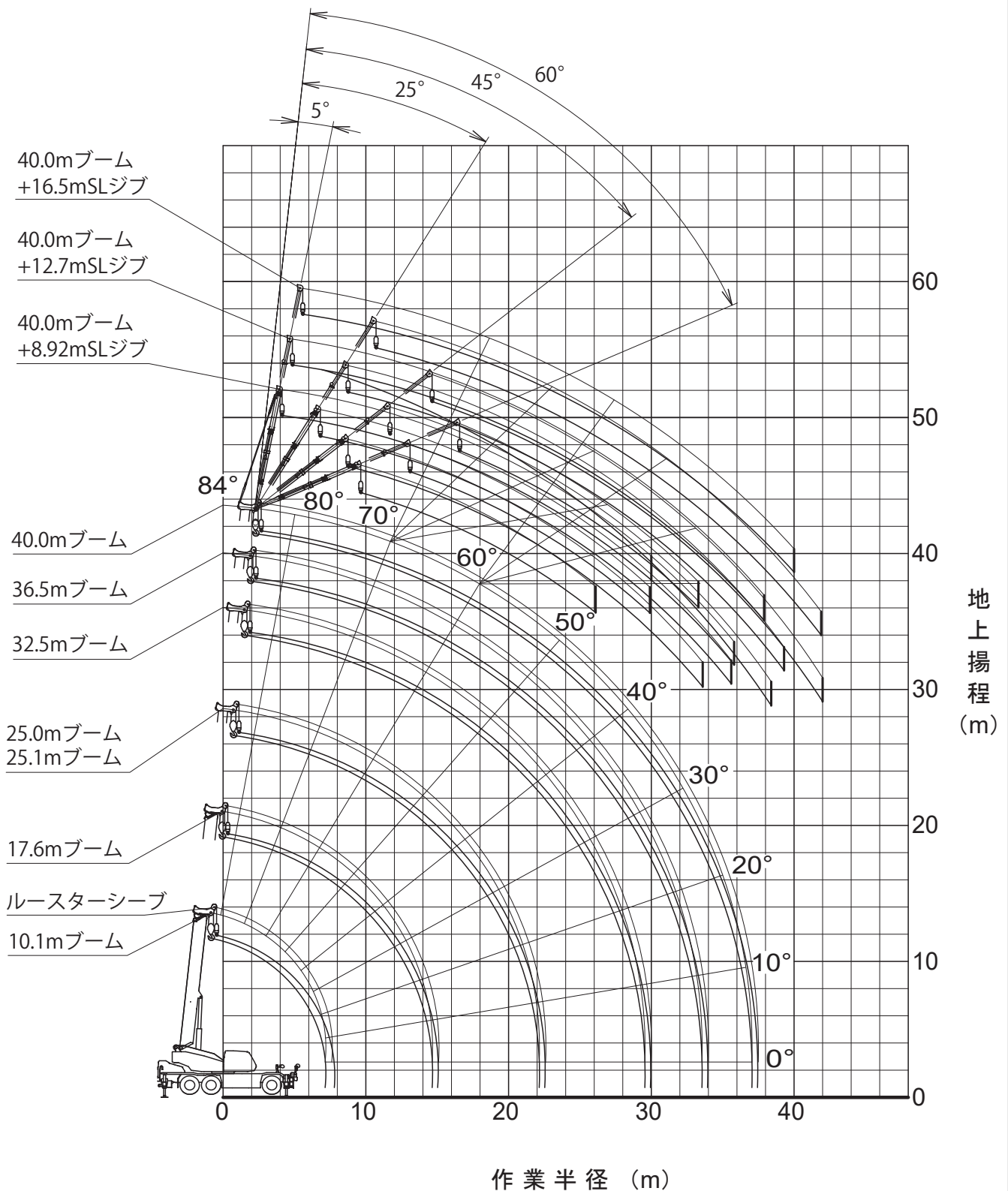

4. ルースタシーブの定格総荷重は、ブームの定格総荷重よりブームに取付けられているフックその他のつり具の質量を差し引いた値とし、かつ限度を5,600kgとします。
【ルースタシーブ使用フック:5.6tフック(質量120kg)巻掛本数1】
5. ブーム長さ25.1m(MODE A、MODE Bでは25.0m)をこえるブーム作業およびジブ作業は行わないでください。
6. 定置つり作業はパーキングブレーキを効かせ、同時にブレーキロックを掛けた状態で行ってください。
7. 走行つりはシフトセレクターを1速にして「低速レンジスイッチ」を押して行ってください。
8. 走行つりは荷が振れないように地面近くに保持し、2km/h 未満にて行ってください。
特にコーナリング、急発進、急制動に注意してください。
9. 走行つり中にはクレーン作業は行わないでください。また、旋回ブレーキを必ず掛けてください。
10. ブーム長さおよび作業半径が規定の値をこえる場合にはその規定の値と、次の規定の値の定格総荷重のうち小さい方の定格総荷重を目安として作業を行ってください。
11. 各々の作業状態における危険角度は表のとおりです。ブームを危険角度以下にしますと無負荷でも転倒しますので充分注意してください。
12. 各ブーム長さに対する標準フック巻掛本数は表のとおりです。ただし標準巻掛本数以外の掛数で使用する場合は、ワイヤロープ1本当たり45.1kN(4.6tf)を限度としてください。
13. クレーン作業は風速10m/sまで可能ですが、比較的弱い風の場合でも受風面積の大きい荷重を取扱う場合は特別な注意を払ってください。
14. 定格総荷重をこえる作業を行った場合、および正しい使い方を行わなかった場合は転倒または破損します。
この場合本機の保証はいたしません。

■作業範囲図











- (注意) 1. 本図はboom・ジブのたわみを含んでいません。
 2. 本図はアウトリガ張出(前方)のものです。

ブーム 	ジブ	アウトリガ  前方	作業範囲 
--	----	--	---

 [m]	10.1	17.6		25.1	25.0	32.5		36.5		40.0	
1.8	60.00	30.00	14.00	15.00	12.50						
2.1	57.00	30.00	14.00	15.00	12.50						
2.5	53.50	30.00	14.00	15.00	12.50						
3.0	50.00	30.00	14.00	15.00	12.50						
3.2	45.00	30.00	14.00	15.00	12.50	12.50	7.50				
3.5	41.00	30.00	14.00	15.00	12.50	12.50	7.50	9.00	7.50		
4.0	37.00	30.00	14.00	15.00	12.50	12.50	7.50	9.00	7.50		
4.5	33.50	30.00	14.00	15.00	12.50	12.50	7.50	9.00	7.50	7.50	
5.0	30.20	28.00	14.00	15.00	12.50	12.50	7.50	9.00	7.50	7.50	
5.5	27.50	26.10	14.00	15.00	12.50	12.50	7.50	9.00	7.50	7.50	
6.0	25.00	24.40	14.00	15.00	12.50	12.50	7.50	9.00	7.50	7.50	
6.5	22.70	22.40	14.00	15.00	12.50	12.50	7.50	9.00	7.50	7.50	
7.0	20.70	20.60	14.00	15.00	11.95	12.50	7.50	9.00	7.50	7.50	
7.5		18.90	14.00	15.00	11.35	12.50	7.50	9.00	7.50	7.50	
8.0		17.50	14.00	15.00	10.70	12.50	7.50	9.00	7.50	7.50	
8.5		16.20	14.00	15.00	10.15	12.50	7.50	9.00	7.50	7.50	
9.0		15.00	13.80	14.50	9.65	12.50	7.50	9.00	7.50	7.50	
10.0		13.00	12.80	13.20	8.80	11.65	6.90	9.00	7.50	7.50	
11.0		11.10	11.80	11.60	8.05	10.70	6.25	9.00	7.20	7.50	
12.0		9.50	10.90	10.40	7.40	9.85	5.70	8.55	6.60	7.40	
13.0		8.20	10.00	9.20	6.85	9.00	5.25	7.90	6.05	6.85	
14.0		7.00	9.35	8.00	6.35	8.30	4.85	7.35	5.60	6.35	
15.0				7.00	5.90	7.60	4.45	6.85	5.20	5.90	
16.0				6.20	5.50	7.00	4.15	6.40	4.80	5.50	
17.0				5.60	5.20	6.40	3.85	6.00	4.50	5.15	
18.0				5.00	4.85	5.80	3.60	5.65	4.20	4.80	
19.0				4.40	4.60	5.20	3.35	5.30	3.90	4.50	
20.0				4.00	4.35	4.60	3.15	5.00	3.70	4.25	
21.0				3.60	4.10	4.20	2.95	4.65	3.45	4.00	
22.0				3.20	3.90	3.80	2.75	4.15	3.25	3.80	
24.0						3.00	2.45	3.35	2.90	3.40	
26.0						2.30	2.20	2.70	2.60	2.80	
28.0						1.80	1.95	2.15	2.35	2.30	
30.0								1.70	2.10	1.80	
32.0								1.35	1.95	1.45	
33.0								1.20	1.85	1.25	
34.0										1.10	
36.0										0.85	
37.0										0.75	
	ブーム2(%)	0	100	0	100	0	100	0	100	50	100
	ブーム3(%)	0	0	33	33	66	66	100	83	100	100
	ブーム4(%)	0	0	33	33	66	66	100	83	100	100
	ブーム5(%)	0	0	33	33	66	66	100	83	100	100
	MODE	A,B	A	B	A	B	A	B	A	B	A,B
 危険 角度	[°]	—	—	—	—	—	—	—	—	—	—
 標準 フック	[ton]	60	34								
 フック 質量	[kg]	500	310								
 巻掛 本数	[本]	13	7	4	6	4	4	4	4	4	4









(単位: ton)

ブーム 	ジブ	アウトリガ  7.6m	作業範囲 
--	----	--	---

 [m]	10.1		17.6		25.1	25.0	32.5		36.5		40.0
	1.8	60.00	30.00	14.00	15.00	12.50					
2.1	57.00	30.00	14.00	15.00	12.50						
2.5	53.50	30.00	14.00	15.00	12.50						
3.0	50.00	30.00	14.00	15.00	12.50						
3.2	45.00	30.00	14.00	15.00	12.50	12.50	7.50				
3.5	41.00	30.00	14.00	15.00	12.50	12.50	7.50	9.00	7.50		
4.0	37.00	30.00	14.00	15.00	12.50	12.50	7.50	9.00	7.50		
4.5	33.50	30.00	14.00	15.00	12.50	12.50	7.50	9.00	7.50	7.50	
5.0	30.20	28.00	14.00	15.00	12.50	12.50	7.50	9.00	7.50	7.50	
5.5	27.50	26.10	14.00	15.00	12.50	12.50	7.50	9.00	7.50	7.50	
6.0	25.00	24.40	14.00	15.00	12.50	12.50	7.50	9.00	7.50	7.50	
6.5	22.70	22.40	14.00	15.00	12.50	12.50	7.50	9.00	7.50	7.50	
7.0	20.70	20.60	14.00	15.00	11.95	12.50	7.50	9.00	7.50	7.50	
7.5		18.90	14.00	15.00	11.35	12.50	7.50	9.00	7.50	7.50	
8.0		17.50	14.00	15.00	10.70	12.50	7.50	9.00	7.50	7.50	
8.5		16.20	14.00	15.00	10.15	12.50	7.50	9.00	7.50	7.50	
9.0		15.00	13.80	14.50	9.65	12.50	7.50	9.00	7.50	7.50	
10.0		12.30	12.80	13.20	8.80	11.65	6.90	9.00	7.50	7.50	
11.0		10.05	11.80	11.20	8.05	10.70	6.25	9.00	7.20	7.50	
12.0		8.35	10.25	9.40	7.40	9.85	5.70	8.55	6.60	7.40	
13.0		7.00	8.85	8.00	6.85	8.60	5.25	7.90	6.05	6.85	
14.0		5.90	7.70	6.90	6.35	7.45	4.85	7.35	5.60	6.35	
15.0				6.00	5.90	6.55	4.45	6.70	5.20	5.90	
16.0				5.25	5.50	5.75	4.15	5.90	4.80	5.50	
17.0				4.60	5.20	5.10	3.85	5.25	4.50	5.15	
18.0				4.00	4.85	4.50	3.60	4.65	4.20	4.80	
19.0				3.50	4.60	4.00	3.35	4.15	3.90	4.30	
20.0				3.05	4.25	3.55	3.15	3.75	3.70	3.90	
21.0				2.65	3.85	3.15	2.95	3.30	3.45	3.45	
22.0				2.30	3.50	2.80	2.75	2.95	3.25	3.10	
24.0						2.15	2.45	2.35	2.70	2.45	
26.0						1.65	2.20	1.80	2.20	1.95	
28.0						1.15	1.95	1.40	1.75	1.50	
30.0								1.00	1.40	1.10	
32.0								0.70	1.10	0.80	
33.0								0.55	1.00	0.65	
34.0										0.50	
	ブーム2(%)	0	100	0	100	0	100	0	100	50	100
	ブーム3(%)	0	0	33	33	66	66	100	83	100	100
	ブーム4(%)	0	0	33	33	66	66	100	83	100	100
	ブーム5(%)	0	0	33	33	66	66	100	83	100	100
	MODE	A,B	A	B	A	B	A	B	A	B	A,B
 危険 角度	[°]	—	—	—	—	—	—	—	—	—	24
 標準 フック	[ton]	60	34								
 フック 質量	[kg]	500	310								
 巻掛 本数	[本]	13	7	4	6	4	4	4	4	4	4







(単位 : ton)

ブーム 	ジブ	アウトリガ  7.2m	作業範囲 
--	----	--	---

 [m]	10.1		17.6		25.1	25.0	32.5		36.5		40.0
	1.8	60.00	30.00	14.00	15.00	12.50					
2.1	57.00	30.00	14.00	15.00	12.50						
2.5	53.50	30.00	14.00	15.00	12.50						
3.0	50.00	30.00	14.00	15.00	12.50						
3.2	45.00	30.00	14.00	15.00	12.50	12.50	7.50				
3.5	41.00	30.00	14.00	15.00	12.50	12.50	7.50	9.00	7.50		
4.0	37.00	30.00	14.00	15.00	12.50	12.50	7.50	9.00	7.50		
4.5	33.50	30.00	14.00	15.00	12.50	12.50	7.50	9.00	7.50	7.50	
5.0	30.20	28.00	14.00	15.00	12.50	12.50	7.50	9.00	7.50	7.50	
5.5	27.50	26.10	14.00	15.00	12.50	12.50	7.50	9.00	7.50	7.50	
6.0	25.00	24.40	14.00	15.00	12.50	12.50	7.50	9.00	7.50	7.50	
6.5	22.70	22.40	14.00	15.00	12.50	12.50	7.50	9.00	7.50	7.50	
7.0	20.70	20.60	14.00	15.00	11.95	12.50	7.50	9.00	7.50	7.50	
7.5		18.90	14.00	15.00	11.35	12.50	7.50	9.00	7.50	7.50	
8.0		17.50	14.00	15.00	10.70	12.50	7.50	9.00	7.50	7.50	
8.5		15.55	14.00	15.00	10.15	12.50	7.50	9.00	7.50	7.50	
9.0		13.75	13.80	14.50	9.65	12.50	7.50	9.00	7.50	7.50	
10.0		11.00	12.80	12.20	8.80	11.65	6.90	9.00	7.50	7.50	
11.0		9.00	10.95	10.10	8.05	10.70	6.25	9.00	7.20	7.50	
12.0		7.45	9.30	8.50	7.40	9.10	5.70	8.55	6.60	7.40	
13.0		6.25	8.05	7.25	6.85	7.80	5.25	7.90	6.05	6.85	
14.0		5.25	7.00	6.25	6.35	6.80	4.85	6.95	5.60	6.35	
15.0				5.40	5.90	5.90	4.45	6.10	5.20	5.90	
16.0				4.70	5.50	5.20	4.15	5.35	4.80	5.50	
17.0				4.05	5.20	4.60	3.85	4.75	4.50	4.85	
18.0				3.50	4.80	4.05	3.60	4.20	4.20	4.35	
19.0				3.00	4.30	3.55	3.35	3.75	3.90	3.85	
20.0				2.55	3.85	3.10	3.15	3.30	3.70	3.45	
21.0				2.15	3.50	2.70	2.95	2.90	3.35	3.05	
22.0				1.80	3.15	2.35	2.75	2.55	3.00	2.70	
24.0						1.75	2.45	1.90	2.40	2.05	
26.0						1.25	2.20	1.40	1.90	1.55	
28.0						0.80	1.85	1.00	1.50	1.10	
30.0								0.65	1.20	0.75	
32.0									0.90		
33.0									0.80		
 ブーム2(%)	0	100	0	100	0	100	0	100	50	100	
 ブーム3(%)	0	0	33	33	66	66	100	83	100	100	
 ブーム4(%)	0	0	33	33	66	66	100	83	100	100	
 ブーム5(%)	0	0	33	33	66	66	100	83	100	100	
MODE	A,B	A	B	A	B	A	B	A	B	A,B	
 危険角度	[°]	—	—	—	—	—	—	25	—	35	
 標準フック	[ton]	60					34				
 フック質量	[kg]	500					310				
 巻掛本数	[本]	13	7	4	6	4	4	4	4	4	4







(単位 : ton)

ブーム 	ジブ	アウトリガ  6.5m	作業範囲 
--	----	--	---



 [m]	10.1		17.6		25.1	25.0	32.5		36.5		40.0
	 [m]	1.8	60.00	30.00	14.00	15.00	12.50				
	2.1	57.00	30.00	14.00	15.00	12.50					
	2.5	53.50	30.00	14.00	15.00	12.50					
	3.0	50.00	30.00	14.00	15.00	12.50					
	3.2	45.00	30.00	14.00	15.00	12.50	12.50	7.50			
	3.5	41.00	30.00	14.00	15.00	12.50	12.50	7.50	9.00	7.50	
	4.0	37.00	30.00	14.00	15.00	12.50	12.50	7.50	9.00	7.50	
	4.5	33.50	30.00	14.00	15.00	12.50	12.50	7.50	9.00	7.50	7.50
	5.0	30.20	28.00	14.00	15.00	12.50	12.50	7.50	9.00	7.50	7.50
	5.5	27.50	26.10	14.00	15.00	12.50	12.50	7.50	9.00	7.50	7.50
	6.0	25.00	24.40	14.00	15.00	12.50	12.50	7.50	9.00	7.50	7.50
	6.5	22.70	22.40	14.00	15.00	12.50	12.50	7.50	9.00	7.50	7.50
	7.0	19.55	18.95	14.00	15.00	11.95	12.50	7.50	9.00	7.50	7.50
	7.5		16.30	14.00	15.00	11.35	12.50	7.50	9.00	7.50	7.50
	8.0		14.20	14.00	15.00	10.70	12.50	7.50	9.00	7.50	7.50
	8.5		12.50	14.00	13.75	10.15	12.50	7.50	9.00	7.50	7.50
	9.0		11.10	13.10	12.30	9.65	12.50	7.50	9.00	7.50	7.50
	10.0		8.90	10.80	10.00	8.80	10.65	6.90	9.00	7.50	7.50
	11.0		7.25	9.05	8.30	8.05	8.90	6.25	8.60	7.20	7.50
	12.0		5.95	7.70	6.95	7.40	7.55	5.70	7.75	6.60	7.40
	13.0		4.95	6.65	5.90	6.85	6.45	5.25	6.65	6.05	6.80
	14.0		4.05	5.80	5.05	6.15	5.55	4.85	5.75	5.60	5.90
	15.0				4.35	5.45	4.85	4.45	5.00	5.20	5.15
	16.0				3.75	4.80	4.25	4.15	4.40	4.75	4.50
	17.0				3.15	4.50	3.70	3.85	3.85	4.40	4.00
	18.0				2.65	4.00	3.25	3.60	3.40	3.90	3.50
	19.0				2.20	3.55	2.80	3.35	3.00	3.45	3.10
	20.0				1.80	3.20	2.40	3.15	2.55	3.05	2.70
	21.0				1.50	2.85	2.05	2.95	2.20	2.70	2.35
	22.0				1.20	2.60	1.70	2.75	1.90	2.40	2.05
	24.0						1.15	2.20	1.35	1.85	1.50
	26.0						0.70	1.80	0.90	1.45	1.05
	28.0							1.45	0.50	1.10	0.65
	30.0									0.80	
	ブーム 2(%)	0	100	0	100	0	100	0	100	50	100
	ブーム 3(%)	0	0	33	33	66	66	100	83	100	100
	ブーム 4(%)	0	0	33	33	66	66	100	83	100	100
	ブーム 5(%)	0	0	33	33	66	66	100	83	100	100
	MODE	A,B	A	B	A	B	A	B	A	B	A,B
 危険 角度	[°]	—	—	—	—	—	26	—	32	25	40
 標準 フック	[ton]	60	34								
 フック 質量	[kg]	500	310								
 巻掛 本数	[本]	13	7	4	6	4	4	4	4	4	4







(単位 : ton)

ブーム 	ジブ	アウトリガ  5.4m	作業範囲 
---	----	---	--

 [m]	10.1		17.6		25.1	25.0	32.5		36.5		40.0
	 [m]	1.8	45.00	30.00	14.00	15.00	12.50				
	2.1	45.00	30.00	14.00	15.00	12.50					
	2.5	45.00	30.00	14.00	15.00	12.50					
	3.0	45.00	30.00	14.00	15.00	12.50					
	3.2	43.30	30.00	14.00	15.00	12.50	12.50	7.50			
	3.5	41.00	30.00	14.00	15.00	12.50	12.50	7.50	9.00	7.50	
	4.0	37.00	30.00	14.00	15.00	12.50	12.50	7.50	9.00	7.50	
	4.5	33.50	30.00	14.00	15.00	12.50	12.50	7.50	9.00	7.50	7.50
	5.0	27.80	26.15	14.00	15.00	12.50	12.50	7.50	9.00	7.50	7.50
	5.5	22.40	21.95	14.00	15.00	12.50	12.50	7.50	9.00	7.50	7.50
	6.0	18.55	18.10	14.00	15.00	12.50	12.50	7.50	9.00	7.50	7.50
	6.5	15.75	15.25	14.00	15.00	12.50	12.50	7.50	9.00	7.50	7.50
	7.0	13.55	13.05	14.00	14.25	11.95	12.50	7.50	9.00	7.50	7.50
	7.5		11.35	13.35	12.55	11.35	12.50	7.50	9.00	7.50	7.50
	8.0		9.90	11.85	11.05	10.70	11.30	7.50	9.00	7.50	7.50
	8.5		8.75	10.60	9.85	10.15	10.30	7.50	9.00	7.50	7.50
	9.0		7.75	9.55	8.80	9.65	9.40	7.50	8.60	7.50	7.50
	10.0		6.15	7.90	7.15	8.35	7.75	6.90	7.90	7.50	7.50
	11.0		4.95	6.60	5.90	7.05	6.45	6.25	6.65	7.00	6.75
	12.0		4.00	5.60	4.90	6.00	5.45	5.70	5.60	5.95	5.75
	13.0		3.15	4.80	4.15	5.20	4.65	5.25	4.80	5.15	4.95
	14.0		2.40	4.15	3.45	4.50	3.95	4.75	4.10	4.45	4.25
	15.0				2.90	3.95	3.40	4.20	3.55	3.90	3.70
	16.0				2.35	3.45	2.90	3.70	3.05	3.40	3.20
	17.0				1.90	3.05	2.45	3.25	2.65	3.15	2.80
	18.0				1.45	2.85	2.05	2.90	2.25	2.75	2.40
	19.0				1.10	2.50	1.65	2.70	1.85	2.35	2.00
	20.0				0.80	2.20	1.35	2.40	1.55	2.05	1.70
	21.0				0.55	1.90	1.05	2.10	1.25	1.80	1.40
	22.0					1.70	0.80	1.85	1.00	1.50	1.10
	24.0							1.45	0.55	1.10	0.65
	26.0							1.10		0.75	
	28.0							0.80			
	ブーム 2(%)	0	100	0	100	0	100	0	100	50	100
	ブーム 3(%)	0	0	33	33	66	66	100	83	100	100
	ブーム 4(%)	0	0	33	33	66	66	100	83	100	100
	ブーム 5(%)	0	0	33	33	66	66	100	83	100	100
	MODE	A,B	A	B	A	B	A	B	A	B	A,B
 危険角度	[°]	—	—	—	17	—	40	—	44	38	50
 標準フック	[ton]	60	34								
 フック質量	[kg]	500	310								
 巻掛本数	[本]	13	7	4	6	4	4	4	4	4	4







(単位 : ton)

ブーム 	ジブ	アウトリガ  4.3m	作業範囲 
--	----	--	---

 [m]	10.1	17.6		25.1	25.0	32.5		36.5		40.0	
1.8	33.00	30.00	14.00	15.00	12.50						
2.1	33.00	30.00	14.00	15.00	12.50						
2.5	33.00	30.00	14.00	15.00	12.50						
3.0	33.00	30.00	14.00	15.00	12.50						
3.2	33.00	30.00	14.00	15.00	12.50	12.50	7.50				
3.5	33.00	30.00	14.00	15.00	12.50	12.50	7.50	9.00	7.50		
4.0	27.40	24.90	14.00	15.00	12.50	12.50	7.50	9.00	7.50		
4.5	21.10	20.40	14.00	15.00	12.50	12.50	7.50	9.00	7.50	7.50	
5.0	16.95	16.60	14.00	15.00	12.50	12.50	7.50	9.00	7.50	7.50	
5.5	14.00	13.65	14.00	14.25	12.50	12.50	7.50	9.00	7.50	7.50	
6.0	11.80	11.45	13.40	12.50	12.50	12.10	7.50	9.00	7.50	7.50	
6.5	10.10	9.70	11.60	10.85	12.15	10.75	7.50	9.00	7.50	7.50	
7.0	8.75	8.35	10.15	9.45	10.65	9.65	7.50	8.60	7.50	7.50	
7.5		7.20	8.95	8.30	9.45	8.70	7.50	8.55	7.50	7.50	
8.0		6.30	8.00	7.30	8.45	7.85	7.50	7.75	7.50	7.50	
8.5		5.50	7.15	6.50	7.60	7.05	7.50	7.05	7.50	7.05	
9.0		4.85	6.45	5.80	6.90	6.35	7.15	6.45	6.85	6.45	
10.0		3.75	5.30	4.65	5.70	5.15	5.95	5.35	5.65	5.40	
11.0		2.90	4.40	3.75	4.80	4.25	5.05	4.45	4.75	4.55	
12.0		2.05	3.70	3.05	4.05	3.55	4.30	3.70	4.00	3.85	
13.0		1.40	3.10	2.50	3.45	2.95	3.70	3.10	3.40	3.25	
14.0		0.85	2.65	1.90	3.00	2.45	3.20	2.60	2.90	2.75	
15.0				1.45	2.55	2.00	2.75	2.20	2.50	2.30	
16.0				1.00	2.20	1.60	2.40	1.75	2.15	1.95	
17.0				0.65	2.05	1.20	2.10	1.40	1.95	1.55	
18.0					1.75	0.90	1.80	1.05	1.65	1.20	
19.0					1.50		1.70		1.35		
20.0					1.25		1.45		1.10		
21.0					1.05		1.25				
22.0					0.85		1.05				
24.0							0.70				
	ブーム2(%)	0	100	0	100	0	100	0	100	50	100
	ブーム3(%)	0	0	33	33	66	66	100	83	100	100
	ブーム4(%)	0	0	33	33	66	66	100	83	100	100
	ブーム5(%)	0	0	33	33	66	66	100	83	100	100
	MODE	A,B	A	B	A	B	A	B	A	B	A,B
 危険 角度	[°]	—	—	—	40	—	52	34	57	53	61
 標準 フック	[ton]	34									
 フック 質量	[kg]	310									
 巻掛 本数	[本]	7	7	4	6	4	4	4	4	4	4

(単位 : ton)

ブーム 	ジブ	アウトリガ  2.43m	作業範囲 
--	----	---	---

 [m]	10.1	17.6		25.1	25.0	32.5		36.5		40.0	
 [m]	1.8	18.35	16.25	14.00	12.85	12.50					
	2.1	18.35	16.25	14.00	12.85	12.50					
	2.5	18.35	16.25	14.00	12.85	12.50					
	3.0	18.35	16.25	14.00	12.85	12.50					
	3.2	16.20	14.80	14.00	11.90	12.50	10.70	7.50			
	3.5	13.70	12.95	14.00	10.70	12.35	9.75	7.50	8.60	7.50	
	4.0	10.70	10.50	12.40	9.05	10.65	8.40	7.50	8.00	7.50	
	4.5	8.60	8.35	10.15	7.70	9.25	7.30	7.50	7.00	7.45	6.80
	5.0	7.05	6.75	8.50	6.60	8.10	6.35	7.45	6.15	6.60	6.00
	5.5	5.85	5.55	7.20	5.70	7.15	5.60	6.65	5.40	5.85	5.30
	6.0	4.90	4.60	6.20	4.95	6.35	4.90	5.95	4.80	5.20	4.70
	6.5	4.15	3.80	5.35	4.25	5.65	4.30	5.35	4.25	4.65	4.20
	7.0	3.55	3.20	4.65	3.70	5.10	3.80	4.85	3.75	4.15	3.70
	7.5		2.65	4.10	3.20	4.50	3.35	4.35	3.30	3.75	3.30
	8.0		2.10	3.60	2.75	4.00	2.95	3.95	2.95	3.35	2.95
	8.5		1.60	3.15	2.35	3.55	2.60	3.60	2.60	3.00	2.60
	9.0			2.80	2.00	3.20	2.25	3.25	2.30	2.70	2.30
10.0			2.20		2.55		2.65		2.15		
11.0			1.70		2.05		2.20		1.70		
12.0			1.40		1.65		1.80				
13.0			1.00		1.40		1.45				
14.0			0.65		1.05		1.15				
15.0					0.75						
	ブーム2(%)	0	100	0	100	0	100	0	100	50	100
	ブーム3(%)	0	0	33	33	66	66	100	83	100	100
	ブーム4(%)	0	0	33	33	66	66	100	83	100	100
	ブーム5(%)	0	0	33	33	66	66	100	83	100	100
	MODE	A,B	A	B	A	B	A	B	A	B	A,B
 危険 角度	[°]	—	53	—	64	47	71	60	73	69	75
 標準 フック	[ton]	34									
 フック 質量	[kg]	310									
 巻掛 本数	[本]	7	7	4	6	4	4	4	4	4	4

(単位 : ton)













SL-600RfII ブーム + SLジブ定格総荷重表



[m]	25.1								25.0									
	5		25		45		60		[°]	5		25		45		60		
	[m]	[ton]	[m]	[ton]	[m]	[ton]	[m]	[ton]		[m]	[ton]	[m]	[ton]	[m]	[ton]	[m]	[ton]	
84.0	3.0	4.20	5.9	4.10	7.7	2.55	8.5	1.70	84.0	3.0	4.20	6.0	4.10	7.8	2.55	8.5	1.70	
80.0	5.5	4.20	8.1	3.80	9.8	2.45	10.5	1.60	80.0	5.5	4.20	8.3	3.80	9.9	2.45	10.5	1.60	
77.0	7.3	4.20	9.8	3.55	11.3	2.35	11.9	1.60	77.0	7.3	4.20	9.9	3.55	11.4	2.35	11.9	1.60	
75.0	8.5	4.20	10.9	3.40	12.3	2.30	12.8	1.55	75.0	8.5	4.20	11.0	3.35	12.4	2.30	12.8	1.55	
72.0	10.3	4.20	12.5	3.25	13.8	2.25	14.2	1.55	72.0	10.3	4.20	12.6	3.20	13.9	2.25	14.1	1.55	
70.0	11.4	4.20	13.5	3.10	14.8	2.20	15.0	1.50	70.0	11.4	4.15	13.6	3.05	14.8	2.20	15.0	1.55	
67.0	13.1	4.05	15.0	2.95	16.2	2.10	16.3	1.50	67.0	13.1	3.80	15.1	2.80	16.2	2.10	16.3	1.50	
65.0	14.2	4.00	16.0	2.80	17.0	2.05	17.1	1.50	65.0	14.2	3.55	16.1	2.65	17.1	2.05	17.1	1.50	
63.0	15.2	3.80	17.0	2.75	17.9	2.05	17.9	1.50	63.0	15.2	3.30	17.0	2.55	17.9	2.05	17.8	1.50	
61.0	16.2	3.60	17.9	2.65	18.7	2.00	18.6	1.45	61.0	16.2	3.10	17.9	2.45	18.7	2.00	18.6	1.45	
58.0	17.6	3.35	19.2	2.50	19.9	2.00			58.0	17.6	2.75	19.2	2.30	19.9	2.00			
55.0	19.0	3.15	20.5	2.40	21.0	1.95			55.0	19.0	2.50	20.5	2.10	21.0	1.95			
52.0	20.4	2.95	21.7	2.30	22.0	1.90			52.0	20.4	2.25	21.7	2.00	22.1	1.90			
50.0	21.2	2.85	22.5	2.25	22.7	1.90			50.0	21.2	2.15	22.5	1.90	22.7	1.85			
48.0	22.1	2.75	23.2	2.20	23.3	1.85			48.0	22.1	2.00	23.2	1.80	23.4	1.80			
46.0	22.9	2.70	23.9	2.20	24.0	1.85			46.0	22.9	1.90	23.9	1.75	24.0	1.75			
44.0	23.7	2.60	24.6	2.10					44.0	23.6	1.80	24.6	1.65					
42.0	24.4	2.50	25.2	2.05					42.0	24.4	1.70	25.2	1.60					
40.0	25.1	2.35	25.8	2.05					40.0	25.1	1.60	25.8	1.55					
35.0	26.7	2.05	27.2	2.00					35.0	26.7	1.40	27.1	1.35					
30.0	28.1	1.80	28.3	1.80					30.0	28.1	1.25	28.3	1.20					
25.0	29.2	1.55							25.0	29.2	1.15							
20.0	30.1	1.35							20.0	30.1	1.05							
15.0	30.8	1.20							15.0	30.7	1.00							
9.0	31.1	1.15							9.0	31.1	0.95							
Boom (%)	ブーム2 (%)	100								ブーム2 (%)	0							
	ブーム3 (%)	33								ブーム3 (%)	66							
	ブーム4 (%)	33								ブーム4 (%)	66							
	ブーム5 (%)	33								ブーム5 (%)	66							
	MODE	A								MODE	B							
危険角度 [°]	8	29	45	60					[°]	8	29	45	60					
標準フック [ton]	5.6								[ton]	5.6								
フック質量 [kg]	120								[kg]	120								
巻掛本数 [本]	1								[本]	1								

 ブーム	 ジブ 8.92m	 アウトリガ 前方	 作業範囲
--	---	--	---

 [m]	40.0							
	5		25		45		60	
	 [°]	 [m]	 [ton]	 [m]	 [ton]	 [m]	 [ton]	 [m]
84.0	5.7	3.80	9.1	3.80	10.5	2.50	11.0	1.65
80.0	9.7	3.80	12.6	3.55	13.9	2.40	14.1	1.55
77.0	12.6	3.80	15.1	3.05	16.4	2.30	16.4	1.55
75.0	14.5	3.80	16.7	2.80	18.0	2.25	17.9	1.55
72.0	17.1	3.20	19.1	2.50	20.2	2.10	20.2	1.50
70.0	18.7	2.85	20.6	2.30	21.6	2.00	21.6	1.50
67.0	21.0	2.45	22.8	2.00	23.7	1.80	23.6	1.50
65.0	22.5	2.20	24.2	1.80	25.0	1.70	24.9	1.50
63.0	24.0	2.00	25.5	1.65	26.3	1.55	26.1	1.45
61.0	25.4	1.80	26.9	1.55	27.5	1.45		
58.0	27.4	1.55	28.9	1.35	29.3	1.30		
55.0	29.4	1.35	30.7	1.20	31.0	1.20		
52.0	31.2	1.10	32.5	1.05	32.6	1.05		
50.0	32.5	1.00	33.6	0.90	33.6	0.90		
48.0	33.6	0.80	34.7	0.75	34.6	0.75		
46.0	34.8	0.60	35.6	0.60				
44.0	35.8	0.45	36.6	0.45				
	ブーム2 (%)	100						
	ブーム3 (%)	100						
	ブーム4 (%)	100						
	ブーム5 (%)	100						
	MODE	A,B						
危険角度	[°]	43	43	47	62			
標準フック	[ton]	5.6						
フック質量	[kg]	120						
巻掛本数	[本]	1						





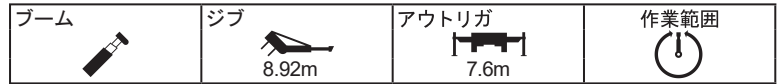













SL-600RfII ブーム + SLジブ定格総荷重表



[m]	25.1								25.0								
	5		25		45		60		[°]	5		25		45		60	
	[m]	[ton]	[m]	[ton]	[m]	[ton]	[m]	[ton]		[m]	[ton]	[m]	[ton]	[m]	[ton]	[m]	[ton]
84.0	3.0	4.20	5.9	4.10	7.7	2.55	8.5	1.70	84.0	3.0	4.20	6.0	4.10	7.8	2.55	8.5	1.70
80.0	5.5	4.20	8.1	3.80	9.8	2.45	10.5	1.60	80.0	5.5	4.20	8.3	3.80	9.9	2.45	10.5	1.60
77.0	7.3	4.20	9.8	3.55	11.3	2.35	11.9	1.60	77.0	7.3	4.20	9.9	3.55	11.4	2.35	11.9	1.60
75.0	8.5	4.20	10.9	3.40	12.3	2.30	12.8	1.55	75.0	8.5	4.20	11.0	3.35	12.4	2.30	12.8	1.55
72.0	10.3	4.20	12.5	3.25	13.8	2.25	14.2	1.55	72.0	10.3	4.20	12.6	3.20	13.9	2.25	14.1	1.55
70.0	11.4	4.20	13.5	3.10	14.8	2.20	15.0	1.50	70.0	11.4	4.15	13.6	3.05	14.8	2.20	15.0	1.55
67.0	13.1	4.05	15.0	2.95	16.2	2.10	16.3	1.50	67.0	13.1	3.80	15.1	2.80	16.2	2.10	16.3	1.50
65.0	14.2	4.00	16.0	2.80	17.0	2.05	17.1	1.50	65.0	14.2	3.55	16.1	2.65	17.1	2.05	17.1	1.50
63.0	15.2	3.80	17.0	2.75	17.9	2.05	17.9	1.50	63.0	15.2	3.30	17.0	2.55	17.9	2.05	17.8	1.50
61.0	16.2	3.60	17.9	2.65	18.7	2.00	18.6	1.45	61.0	16.2	3.10	17.9	2.45	18.7	2.00	18.6	1.45
58.0	17.6	3.35	19.2	2.50	19.9	2.00			58.0	17.6	2.75	19.2	2.30	19.9	2.00		
55.0	19.0	3.15	20.5	2.40	21.0	1.95			55.0	19.0	2.50	20.5	2.10	21.0	1.95		
52.0	20.4	2.95	21.7	2.30	22.0	1.90			52.0	20.4	2.25	21.7	2.00	22.1	1.90		
50.0	21.2	2.75	22.5	2.25	22.7	1.90			50.0	21.2	2.15	22.5	1.90	22.7	1.85		
48.0	22.1	2.45	23.2	2.20	23.3	1.85			48.0	22.1	2.00	23.2	1.80	23.4	1.80		
46.0	22.9	2.20	23.9	2.05	24.0	1.85			46.0	22.9	1.90	23.9	1.75	24.0	1.75		
44.0	23.6	1.95	24.6	1.85					44.0	23.6	1.80	24.6	1.65				
42.0	24.4	1.75	25.2	1.70					42.0	24.4	1.70	25.2	1.60				
40.0	25.1	1.55	25.8	1.55					40.0	25.1	1.60	25.8	1.55				
35.0	26.6	1.20	27.1	1.20					35.0	26.7	1.40	27.1	1.35				
30.0	28.0	0.90	28.3	0.90					30.0	28.1	1.25	28.3	1.20				
25.0	29.1	0.65							25.0	29.2	1.15						
20.0	30.1	0.50							20.0	30.1	1.05						
18.0	30.4	0.45							15.0	30.7	1.00						
									9.0	31.1	0.95						
ブーム2 (%)	100								ブーム2 (%)	0							
	33								ブーム3 (%)	66							
	33								ブーム4 (%)	66							
	33								ブーム5 (%)	66							
	MODE A								MODE	MODE B							
危険角度 [°]	17		29		45		60	[°]	8		29		45		60		
標準フック [ton]	5.6								[ton]	5.6							
フック質量 [kg]	120								[kg]	120							
巻掛本数 [本]	1								[本]	1							

 ブーム	 ジブ 8.92m	 アウトリガ 7.6m	 作業範囲
--	---	--	---

 [m]	40.0								
	5		25		45		60		
 [°]									
	 [°]	[m]	[ton]	[m]	[ton]	[m]	[ton]	[m]	[ton]
84.0	5.7	3.80	9.1	3.80	10.5	2.50	11.0	1.65	
80.0	9.7	3.80	12.6	3.55	13.9	2.40	14.1	1.55	
77.0	12.6	3.80	15.1	3.05	16.4	2.30	16.4	1.55	
75.0	14.5	3.80	16.7	2.80	18.0	2.25	17.9	1.55	
72.0	17.1	3.20	19.1	2.50	20.2	2.10	20.2	1.50	
70.0	18.7	2.85	20.6	2.30	21.6	2.00	21.6	1.50	
67.0	21.0	2.45	22.8	2.00	23.7	1.80	23.6	1.50	
65.0	22.5	2.20	24.2	1.80	25.0	1.70	24.9	1.50	
63.0	24.0	2.00	25.5	1.65	26.3	1.55	26.1	1.45	
61.0	25.4	1.70	26.9	1.55	27.5	1.45			
58.0	27.2	1.25	28.7	1.15	29.3	1.15			
55.0	29.1	0.90	30.5	0.80	30.9	0.80			
53.0	30.3	0.65	31.6	0.65	31.9	0.65			
	ブーム2 (%)	100							
	ブーム3 (%)	100							
	ブーム4 (%)	100							
	ブーム5 (%)	100							
	MODE	A,B							
 危険角度	[°]	52	52	52	52	52	62		
 標準フック	[ton]	5.6							
 フック質量	[kg]	120							
 巻掛本数	[本]	1							





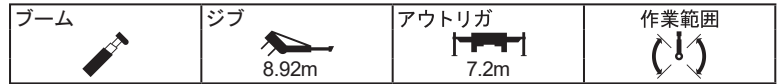







SL-600RfII ブーム + SLジブ定格総荷重表



[m]	25.1								25.0								
	5		25		45		60		[°]	5		25		45		60	
	[m]	[ton]	[m]	[ton]	[m]	[ton]	[m]	[ton]		[m]	[ton]	[m]	[ton]	[m]	[ton]	[m]	[ton]
84.0	3.0	4.20	5.9	4.10	7.7	2.55	8.5	1.70	84.0	3.0	4.20	6.0	4.10	7.8	2.55	8.5	1.70
80.0	5.5	4.20	8.1	3.80	9.8	2.45	10.5	1.60	80.0	5.5	4.20	8.3	3.80	9.9	2.45	10.5	1.60
77.0	7.3	4.20	9.8	3.55	11.3	2.35	11.9	1.60	77.0	7.3	4.20	9.9	3.55	11.4	2.35	11.9	1.60
75.0	8.5	4.20	10.9	3.40	12.3	2.30	12.8	1.55	75.0	8.5	4.20	11.0	3.35	12.4	2.30	12.8	1.55
72.0	10.3	4.20	12.5	3.25	13.8	2.25	14.2	1.55	72.0	10.3	4.20	12.6	3.20	13.9	2.25	14.1	1.55
70.0	11.4	4.20	13.5	3.10	14.8	2.20	15.0	1.50	70.0	11.4	4.15	13.6	3.05	14.8	2.20	15.0	1.55
67.0	13.1	4.05	15.0	2.95	16.2	2.10	16.3	1.50	67.0	13.1	3.80	15.1	2.80	16.2	2.10	16.3	1.50
65.0	14.2	4.00	16.0	2.80	17.0	2.05	17.1	1.50	65.0	14.2	3.55	16.1	2.65	17.1	2.05	17.1	1.50
63.0	15.2	3.80	17.0	2.75	17.9	2.05	17.9	1.50	63.0	15.2	3.30	17.0	2.55	17.9	2.05	17.8	1.50
61.0	16.2	3.60	17.9	2.65	18.7	2.00	18.6	1.45	61.0	16.2	3.10	17.9	2.45	18.7	2.00	18.6	1.45
58.0	17.6	3.35	19.2	2.50	19.9	2.00			58.0	17.6	2.75	19.2	2.30	19.9	2.00		
55.0	19.0	3.15	20.5	2.40	21.0	1.95			55.0	19.0	2.50	20.5	2.10	21.0	1.95		
52.0	20.4	2.70	21.7	2.30	22.0	1.90			52.0	20.4	2.25	21.7	2.00	22.1	1.90		
50.0	21.2	2.40	22.6	2.20	22.7	1.90			50.0	21.2	2.15	22.5	1.90	22.7	1.85		
48.0	22.0	2.10	23.5	1.90	23.3	1.85			48.0	22.1	2.00	23.2	1.80	23.4	1.80		
46.0	22.8	1.90	24.3	1.65	23.9	1.65			46.0	22.9	1.90	23.9	1.75	24.0	1.75		
44.0	23.6	1.65	24.9	1.50					44.0	23.6	1.80	24.6	1.65				
42.0	24.3	1.45	25.4	1.35					42.0	24.4	1.70	25.2	1.60				
40.0	25.0	1.30	25.9	1.25					40.0	25.1	1.60	25.8	1.55				
35.0	26.6	0.95	27.1	0.95					35.0	26.7	1.40	27.1	1.35				
30.0	28.0	0.65	28.2	0.65					30.0	28.1	1.25	28.3	1.20				
25.0	29.1	0.45							25.0	29.2	1.15						
									20.0	30.1	1.05						
									15.0	30.7	1.00						
									9.0	31.2	0.90						
ブーム2 (%)	100								ブーム2 (%)	0							
	33								ブーム3 (%)	66							
	33								ブーム4 (%)	66							
	33								ブーム5 (%)	66							
	MODE A								MODE	MODE B							
危険角度 [°]	24		29		45		60	[°]	8		29		45		60		
標準フック [ton]	5.6								[ton]	5.6							
フック質量 [kg]	120								[kg]	120							
巻掛本数 [本]	1								[本]	1							















 ブーム	 ジブ 8.92m	 アウトリガ 7.2m	 作業範囲
--	---	--	---

 [m]	40.0								
	5		25		45		60		
	 [°]	 [m]	 [ton]	 [°]	 [m]	 [ton]	 [°]	 [m]	 [ton]
84.0	5.7	3.80	9.1	3.80	10.5	2.50	11.0	1.65	
80.0	9.7	3.80	12.6	3.55	13.9	2.40	14.1	1.55	
77.0	12.6	3.80	15.1	3.05	16.4	2.30	16.4	1.55	
75.0	14.5	3.80	16.7	2.80	18.0	2.25	17.9	1.55	
72.0	17.1	3.20	19.1	2.50	20.2	2.10	20.2	1.50	
70.0	18.7	2.85	20.6	2.30	21.6	2.00	21.6	1.50	
67.0	21.0	2.45	22.8	2.00	23.7	1.80	23.6	1.50	
65.0	22.5	2.20	24.2	1.80	25.0	1.70	24.9	1.50	
63.0	24.0	1.75	25.5	1.60	26.3	1.55	26.1	1.45	
61.0	25.1	1.45	26.9	1.30	27.5	1.30			
58.0	27.1	1.00	28.6	0.95	29.0	0.95			
56.0	28.4	0.80	29.8	0.70	30.2	0.70			
	ブーム2 (%)	100							
	ブーム3 (%)	100							
	ブーム4 (%)	100							
	ブーム5 (%)	100							
	MODE	A,B							
危険角度	[°]	55	55	55	55	55	62		
標準フック	[ton]	5.6							
フック質量	[kg]	120							
巻掛本数	[本]	1							



[m]	25.1								25.0									
	5		25		45		60		[°]	5		25		45		60		
	[m]	[ton]	[m]	[ton]	[m]	[ton]	[m]	[ton]		[m]	[ton]	[m]	[ton]	[m]	[ton]	[m]	[ton]	
84.0	3.0	4.20	5.9	4.10	7.7	2.55	8.5	1.70	84.0	3.0	4.20	6.0	4.10	7.8	2.55	8.5	1.70	
80.0	5.5	4.20	8.1	3.80	9.8	2.45	10.5	1.60	80.0	5.5	4.20	8.3	3.80	9.9	2.45	10.5	1.60	
77.0	7.3	4.20	9.8	3.55	11.3	2.35	11.9	1.60	77.0	7.3	4.20	9.9	3.55	11.4	2.35	11.9	1.60	
75.0	8.5	4.20	10.9	3.40	12.3	2.30	12.8	1.55	75.0	8.5	4.20	11.0	3.35	12.4	2.30	12.8	1.55	
72.0	10.3	4.20	12.5	3.25	13.8	2.25	14.2	1.55	72.0	10.3	4.20	12.6	3.20	13.9	2.25	14.1	1.55	
70.0	11.4	4.20	13.5	3.10	14.8	2.20	15.0	1.50	70.0	11.4	4.15	13.6	3.05	14.8	2.20	15.0	1.55	
67.0	13.1	4.05	15.0	2.95	16.2	2.10	16.3	1.50	67.0	13.1	3.80	15.1	2.80	16.2	2.10	16.3	1.50	
65.0	14.2	4.00	16.0	2.80	17.0	2.05	17.1	1.50	65.0	14.2	3.55	16.1	2.65	17.1	2.05	17.1	1.50	
63.0	15.2	3.80	17.0	2.75	17.9	2.05	17.9	1.50	63.0	15.2	3.30	17.0	2.55	17.9	2.05	17.8	1.50	
61.0	16.2	3.60	17.9	2.65	18.7	2.00	18.6	1.45	61.0	16.2	3.10	17.9	2.45	18.7	2.00	18.6	1.45	
58.0	17.6	3.20	19.2	2.50	19.9	2.00			58.0	17.6	2.75	19.2	2.30	19.9	2.00			
55.0	19.0	2.55	20.5	2.30	21.0	1.95			55.0	19.0	2.50	20.5	2.10	21.0	1.95			
52.0	20.4	2.05	21.7	1.90	22.0	1.90			52.0	20.4	2.25	21.7	2.00	22.1	1.90			
50.0	21.1	1.80	22.4	1.65	22.7	1.65			50.0	21.2	2.15	22.5	1.90	22.7	1.85			
48.0	21.9	1.55	23.1	1.45	23.3	1.45			48.0	22.1	2.00	23.2	1.80	23.4	1.80			
46.0	22.7	1.35	23.8	1.25	23.9	1.25			46.0	22.9	1.90	23.9	1.75	24.0	1.75			
44.0	23.5	1.15	24.5	1.10					44.0	23.6	1.80	24.6	1.65					
42.0	24.2	1.00	25.1	0.95					42.0	24.4	1.70	25.2	1.60					
40.0	24.9	0.80	25.7	0.80					40.0	25.1	1.55	25.8	1.55					
35.0	26.5	0.50	27.1	0.50					35.0	26.7	1.25	27.2	1.25					
34.0	26.8	0.45							30.0	28.0	1.00	28.2	1.00					
									25.0	29.2	0.80							
									20.0	30.1	0.70							
									15.0	30.7	0.60							
									9.0	31.1	0.55							
[°]	ブーム2 (%)	100								ブーム2 (%)	0							
	ブーム3 (%)	33								ブーム3 (%)	66							
	ブーム4 (%)	33								ブーム4 (%)	66							
	ブーム5 (%)	33								ブーム5 (%)	66							
	MODE	A								MODE	B							
危険角度 [°]	33	34	45	60					[°]	8	29	45	60					
標準フック [ton]	5.6								[ton]	5.6								
フック質量 [kg]	120								[kg]	120								
巻掛本数 [本]	1								[本]	1								















 ブーム	 ジブ 8.92m	 アウトリガ 6.5m	 作業範囲
--	---	--	---

 [m]	40.0								
	5		25		45		60		
	 [°]	 [m]	 [ton]	 [m]	 [ton]	 [m]	 [ton]	 [m]	 [ton]
84.0	5.7	3.80	9.1	3.80	10.5	2.50	11.0	1.65	
80.0	9.7	3.80	12.6	3.55	13.9	2.40	14.1	1.55	
77.0	12.6	3.80	15.1	3.05	16.4	2.30	16.4	1.55	
75.0	14.5	3.80	16.7	2.80	18.0	2.25	17.9	1.55	
72.0	17.1	3.20	19.1	2.50	20.2	2.10	20.2	1.50	
70.0	18.7	2.85	20.6	2.30	21.6	2.00	21.6	1.50	
67.0	20.8	2.10	22.7	1.85	23.7	1.75	23.6	1.50	
65.0	22.2	1.70	24.0	1.50	24.8	1.45	24.9	1.45	
63.0	23.5	1.35	25.3	1.20	26.0	1.15	26.0	1.15	
61.0	24.9	1.00	26.6	0.90	27.2	0.90			
	ブーム2 (%)	100							
	ブーム3 (%)	100							
	ブーム4 (%)	100							
	ブーム5 (%)	100							
	MODE	A,B							
 危険角度	[°]	60	60	60	60	60	62		
 標準フック	[ton]	5.6							
 フック質量	[kg]	120							
 巻掛本数	[本]	1							

























[m]	25.1								25.0									
	5		25		45		60		[°]	5		25		45		60		
	[m]	[ton]	[m]	[ton]	[m]	[ton]	[m]	[ton]		[m]	[ton]	[m]	[ton]	[m]	[ton]	[m]	[ton]	
84.0	3.0	4.20	5.9	4.10	7.7	2.55	8.5	1.70	84.0	3.0	4.20	6.0	4.10	7.8	2.55	8.5	1.70	
80.0	5.5	4.20	8.1	3.80	9.8	2.45	10.5	1.60	80.0	5.5	4.20	8.3	3.80	9.9	2.45	10.5	1.60	
77.0	7.3	4.20	9.8	3.55	11.3	2.35	11.9	1.60	77.0	7.3	4.20	9.9	3.55	11.4	2.35	11.9	1.60	
75.0	8.5	4.20	10.9	3.40	12.3	2.30	12.8	1.55	75.0	8.5	4.20	11.0	3.35	12.4	2.30	12.8	1.55	
72.0	10.3	4.20	12.5	3.25	13.8	2.25	14.2	1.55	72.0	10.3	4.20	12.6	3.20	13.9	2.25	14.1	1.55	
70.0	11.4	4.20	13.5	3.10	14.8	2.20	15.0	1.50	70.0	11.4	4.15	13.6	3.05	14.8	2.20	15.0	1.55	
67.0	13.1	4.05	15.0	2.95	16.2	2.10	16.3	1.50	67.0	13.1	3.80	15.1	2.80	16.2	2.10	16.3	1.50	
65.0	14.1	3.80	16.0	2.80	17.0	2.05	17.1	1.50	65.0	14.2	3.55	16.1	2.65	17.1	2.05	17.1	1.50	
63.0	15.1	3.20	17.0	2.70	17.9	2.05	17.9	1.50	63.0	15.2	3.30	17.0	2.55	17.9	2.05	17.8	1.50	
61.0	16.1	2.70	17.9	2.30	18.7	2.00	18.6	1.45	61.0	16.2	3.10	17.9	2.45	18.7	2.00	18.6	1.45	
58.0	17.5	2.10	19.2	1.80	19.8	1.75			58.0	17.6	2.75	19.2	2.30	19.9	2.00			
55.0	18.8	1.60	20.4	1.40	20.9	1.40			55.0	19.0	2.30	20.5	2.10	21.0	1.95			
52.0	20.2	1.20	21.6	1.05	21.9	1.05			52.0	20.3	1.90	21.7	1.75	22.0	1.75			
50.0	21.0	0.95	22.3	0.85	22.6	0.85			50.0	21.2	1.65	22.4	1.55	22.6	1.55			
48.0	21.8	0.75	23.0	0.70	23.3	0.70			48.0	22.0	1.45	23.1	1.40	23.3	1.40			
46.0	22.6	0.55	23.8	0.50	23.9	0.50			46.0	22.8	1.30	23.8	1.20	23.9	1.20			
45.0	23.0	0.45							44.0	23.6	1.15	24.5	1.10					
									42.0	24.3	1.00	25.1	0.95					
									40.0	25.0	0.85	25.7	0.85					
									35.0	26.5	0.60	27.1	0.60					
									32.0	27.3	0.50	27.8	0.50					
[°]	ブーム2 (%)	100								ブーム2 (%)	0							
	ブーム3 (%)	33								ブーム3 (%)	66							
	ブーム4 (%)	33								ブーム4 (%)	66							
	ブーム5 (%)	33								ブーム5 (%)	66							
	MODE	A								MODE	B							
危険角度 [°]	44	45	45	60					31	31	45	60						
標準フック [ton]	5.6								[ton]	5.6								
フック質量 [kg]	120								[kg]	120								
巻掛本数 [本]	1								[本]	1								















 ブーム	 ジブ 8.92m	 アウトリガ 5.4m	 作業範囲
--	---	--	---

 [m]	40.0							
	5		25		45		60	
 [°]	 [m]	 [ton]	 [m]	 [ton]	 [m]	 [ton]	 [m]	 [ton]
	84.0	5.7	3.80	9.1	3.80	10.5	2.50	11.0
80.0	9.7	3.80	12.6	3.55	13.9	2.40	14.1	1.55
77.0	12.6	3.80	15.1	3.05	16.4	2.30	16.4	1.55
75.0	14.5	3.55	16.7	2.80	18.0	2.25	17.9	1.55
72.0	16.7	2.55	18.8	2.20	20.2	1.95	20.2	1.50
70.0	18.2	2.00	20.3	1.70	21.4	1.60	21.6	1.50
67.0	20.3	1.35	22.3	1.15	23.3	1.05	23.4	1.05
	ブーム2 (%)	100						
	ブーム3 (%)	100						
	ブーム4 (%)	100						
	ブーム5 (%)	100						
	MODE	A,B						
 危険角度	[°]	66	66	66	66	66	66	66
 標準フック	[ton]	5.6						
 フック質量	[kg]	120						
 巻掛本数	[本]	1						



 [m]	25.1								25.0									
	5		25		45		60		[°]	5		25		45		60		
	 [°]	 [m]	 [ton]	 [m]	 [ton]	 [m]	 [ton]	 [m]		 [ton]	 [°]	 [m]	 [ton]	 [m]	 [ton]	 [m]	 [ton]	 [m]
84.0	3.0	4.20	5.9	4.10	7.7	2.55	8.5	1.70	84.0	3.0	4.20	6.0	4.10	7.8	2.55	8.5	1.70	
80.0	5.5	4.20	8.1	3.80	9.8	2.45	10.5	1.60	80.0	5.5	4.20	8.3	3.80	9.9	2.45	10.5	1.60	
77.0	7.3	4.20	9.8	3.55	11.3	2.35	11.9	1.60	77.0	7.3	4.20	9.9	3.55	11.4	2.35	11.9	1.60	
75.0	8.5	4.20	10.9	3.40	12.3	2.30	12.8	1.55	75.0	8.5	4.20	11.0	3.35	12.4	2.30	12.8	1.55	
72.0	10.3	4.20	12.5	3.25	13.8	2.25	14.2	1.55	72.0	10.3	4.20	12.6	3.20	13.9	2.25	14.1	1.55	
70.0	11.4	4.00	13.5	3.10	14.8	2.20	15.0	1.50	70.0	11.4	4.15	13.6	3.05	14.8	2.20	15.0	1.55	
67.0	13.1	2.90	15.0	2.40	16.2	2.10	16.3	1.50	67.0	13.1	3.60	15.1	2.80	16.2	2.10	16.3	1.50	
65.0	14.0	2.40	16.0	2.00	17.0	1.85	17.1	1.50	65.0	14.2	3.05	16.1	2.55	17.1	2.05	17.1	1.50	
63.0	14.9	2.00	16.9	1.60	17.8	1.50	17.9	1.50	63.0	15.1	2.60	17.0	2.25	17.9	2.05	17.8	1.50	
61.0	15.9	1.55	17.8	1.30	18.6	1.25	18.6	1.25	61.0	16.1	2.25	17.9	1.95	18.7	1.85	18.6	1.45	
58.0	17.3	1.05	19.1	0.90	19.8	0.85			58.0	17.5	1.80	19.1	1.55	19.9	1.50			
57.0	17.8	0.90							55.0	18.8	1.40	20.4	1.25	21.0	1.20			
									52.0	20.2	1.05	21.6	0.95	22.0	0.95			
									50.0	21.0	0.85	22.4	0.80	22.6	0.80			
									48.0	21.9	0.70	23.1	0.65	23.2	0.65			
									46.0	22.6	0.55	23.8	0.50	23.9	0.50			
									45.0	23.0	0.50	24.1	0.45					
	ブーム2 (%)	100								ブーム2 (%)	0							
	ブーム3 (%)	33								ブーム3 (%)	66							
	ブーム4 (%)	33								ブーム4 (%)	66							
	ブーム5 (%)	33								ブーム5 (%)	66							
	MODE	A								MODE	B							
 危険角度	[°]	56	57	57	60	[°]	44	44	45	60								
 標準フック	[ton]	5.6								[ton]	5.6							
 フック質量	[kg]	120								[kg]	120							
 巻掛本数	[本]	1								[本]	1							

 ブーム	 ジブ 8.92m	 アウトリガ 4.3m	 作業範囲
--	---	--	---

 [m]	40.0							
	5		25		45		60	
 [°]	 [m]	 [ton]	 [m]	 [ton]	 [m]	 [ton]	 [m]	 [ton]
	84.0	5.7	3.80	9.1	3.80	10.5	2.50	11.0
80.0	9.7	3.80	12.6	3.55	13.9	2.40	14.1	1.55
77.0	12.6	3.10	15.0	2.55	16.4	2.25	16.4	1.55
75.0	13.9	2.45	16.3	2.00	17.7	1.80	17.9	1.55
73.0	15.4	1.80	17.7	1.50				
	ブーム2 (%)	100						
	ブーム3 (%)	100						
	ブーム4 (%)	100						
	ブーム5 (%)	100						
	MODE	A,B						
 危険角度	[°]	72	72	74	74			
 標準フック	[ton]	5.6						
 フック質量	[kg]	120						
 巻掛本数	[本]	1						





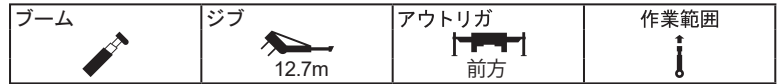







SL-600RfII ブーム + SLジブ定格総荷重表



[m]	25.1								25.0									
	5		25		45		60		[°]	5		25		45		60		
	[m]	[ton]	[m]	[ton]	[m]	[ton]	[m]	[ton]		[m]	[ton]	[m]	[ton]	[m]	[ton]	[m]	[ton]	
84.0	3.8	2.80	7.9	2.65	10.8	1.80	12.0	1.15	84.0	3.9	2.80	8.2	2.65	11.0	1.75	12.2	1.15	
80.0	6.5	2.80	10.4	2.60	13.1	1.65	14.1	1.15	80.0	6.7	2.80	10.7	2.60	13.3	1.65	14.3	1.15	
77.0	8.5	2.75	12.3	2.45	14.7	1.65	15.5	1.15	77.0	8.7	2.75	12.5	2.40	14.9	1.65	15.7	1.15	
75.0	9.9	2.75	13.5	2.35	15.7	1.60	16.5	1.10	75.0	10.1	2.75	13.7	2.30	15.9	1.60	16.7	1.10	
72.0	11.8	2.70	15.5	2.15	17.3	1.50	17.9	1.10	72.0	12.0	2.70	15.4	2.15	17.4	1.50	18.0	1.10	
70.0	13.1	2.70	16.8	2.10	18.2	1.50	18.8	1.10	70.0	13.3	2.70	16.6	2.10	18.4	1.50	18.9	1.10	
67.0	15.0	2.70	18.4	1.95	19.7	1.45	20.0	1.10	67.0	15.2	2.65	18.2	1.95	19.8	1.45	20.2	1.10	
65.0	16.2	2.65	19.3	1.90	20.6	1.45	20.9	1.10	65.0	16.4	2.60	19.3	1.90	20.7	1.45	21.0	1.10	
63.0	17.4	2.60	20.2	1.80	21.5	1.40	21.6	1.10	63.0	17.6	2.50	20.3	1.80	21.6	1.40	21.7	1.10	
61.0	18.5	2.60	21.1	1.75	22.4	1.40	22.4	1.05	61.0	18.7	2.30	21.3	1.75	22.5	1.40	22.5	1.05	
58.0	20.2	2.45	22.5	1.70	23.6	1.40			58.0	20.3	2.10	22.7	1.60	23.7	1.40			
55.0	21.7	2.30	23.9	1.65	24.7	1.35			55.0	21.8	1.95	23.9	1.55	24.8	1.35			
52.0	23.2	2.15	25.1	1.60	25.8	1.35			52.0	23.3	1.75	25.2	1.45	25.9	1.35			
50.0	24.1	2.05	26.0	1.60	26.5	1.35			50.0	24.2	1.65	26.0	1.35	26.5	1.35			
48.0	25.1	2.00	26.8	1.55	27.1	1.30			48.0	25.1	1.60	26.8	1.35	27.1	1.30			
46.0	25.9	1.95	27.5	1.50	27.7	1.30			46.0	26.0	1.55	27.5	1.30	27.7	1.30			
44.0	26.8	1.85	28.2	1.50					44.0	26.8	1.45	28.2	1.25					
42.0	27.6	1.80	28.9	1.50					42.0	27.6	1.40	28.9	1.25					
40.0	28.4	1.75	29.5	1.45					40.0	28.4	1.35	29.5	1.20					
35.0	30.2	1.60	30.9	1.40					35.0	30.1	1.15	30.9	1.10					
30.0	31.7	1.50	32.1	1.35					30.0	31.6	1.05	32.1	1.00					
25.0	32.9	1.25							25.0	32.8	0.95							
20.0	33.8	1.10							20.0	33.7	0.90							
15.0	34.5	1.00							15.0	34.4	0.80							
10.0	34.9	0.95							10.0	34.8	0.75							
Boom (%)	ブーム2 (%)	100								ブーム2 (%)	0							
	ブーム3 (%)	33								ブーム3 (%)	66							
	ブーム4 (%)	33								ブーム4 (%)	66							
	ブーム5 (%)	33								ブーム5 (%)	66							
	MODE	A								MODE	B							
危険角度 [°]	9	29	45	60					[°]	9	29	45	60					
標準フック [ton]	5.6								[ton]	5.6								
フック質量 [kg]	120								[kg]	120								
巻掛本数 [本]	1								[本]	1								

 ブーム	 ジブ 12.7m	 アウトリガ 前方	 作業範囲
--	---	--	---

 [m]	40.0							
	5		25		45		60	
	 [°]	 [m]	 [ton]	 [°]	 [m]	 [ton]	 [°]	 [m]
84.0	6.5	2.80	11.2	2.65	13.7	1.75	14.6	1.10
80.0	10.9	2.75	15.1	2.45	17.2	1.65	17.9	1.05
77.0	14.0	2.70	17.8	2.20	19.7	1.60	20.2	1.05
75.0	16.1	2.65	19.5	2.05	21.3	1.55	21.7	1.05
72.0	19.0	2.60	22.0	1.85	23.7	1.50	23.9	1.05
70.0	20.9	2.40	23.6	1.70	25.2	1.40	25.3	1.05
67.0	23.3	1.95	25.9	1.55	27.3	1.30	27.4	1.05
65.0	24.8	1.75	27.4	1.40	28.7	1.25	28.7	1.05
63.0	26.4	1.60	28.9	1.30	30.1	1.15	29.9	1.00
61.0	27.9	1.45	30.3	1.20	31.3	1.10		
58.0	30.2	1.25	32.3	1.05	33.1	0.95		
55.0	32.3	1.10	34.2	0.95	34.8	0.90		
52.0	34.2	0.95	36.0	0.80	36.4	0.80		
50.0	35.5	0.85	37.2	0.75	37.4	0.75		
48.0	36.7	0.65	38.3	0.65	38.4	0.65		
46.0	37.9	0.50	39.3	0.50				
	ブーム2 (%)	100						
	ブーム3 (%)	100						
	ブーム4 (%)	100						
	ブーム5 (%)	100						
	MODE	A,B						
危険角度	[°]	45	45	47	62			
標準フック	[ton]	5.6						
フック質量	[kg]	120						
巻掛本数	[本]	1						













SL-600RfII ブーム + SLジブ定格総荷重表



[m]	25.1								25.0									
	5		25		45		60		[°]	5		25		45		60		
	[m]	[ton]	[m]	[ton]	[m]	[ton]	[m]	[ton]		[m]	[ton]	[m]	[ton]	[m]	[ton]	[m]	[ton]	
84.0	3.8	2.80	7.9	2.65	10.8	1.80	12.0	1.15	84.0	3.9	2.80	8.2	2.65	11.0	1.75	12.2	1.15	
80.0	6.5	2.80	10.4	2.60	13.1	1.65	14.1	1.15	80.0	6.7	2.80	10.7	2.60	13.3	1.65	14.3	1.15	
77.0	8.5	2.75	12.3	2.45	14.7	1.65	15.5	1.15	77.0	8.7	2.75	12.5	2.40	14.9	1.65	15.7	1.15	
75.0	9.9	2.75	13.5	2.35	15.7	1.60	16.5	1.10	75.0	10.1	2.75	13.7	2.30	15.9	1.60	16.7	1.10	
72.0	11.8	2.70	15.5	2.15	17.3	1.50	17.9	1.10	72.0	12.0	2.70	15.4	2.15	17.4	1.50	18.0	1.10	
70.0	13.1	2.70	16.8	2.10	18.2	1.50	18.8	1.10	70.0	13.3	2.70	16.6	2.10	18.4	1.50	18.9	1.10	
67.0	15.0	2.70	18.4	1.95	19.7	1.45	20.0	1.10	67.0	15.2	2.65	18.2	1.95	19.8	1.45	20.2	1.10	
65.0	16.2	2.65	19.3	1.90	20.6	1.45	20.9	1.10	65.0	16.4	2.60	19.3	1.90	20.7	1.45	21.0	1.10	
63.0	17.4	2.60	20.2	1.80	21.5	1.40	21.6	1.10	63.0	17.6	2.50	20.3	1.80	21.6	1.40	21.7	1.10	
61.0	18.5	2.60	21.1	1.75	22.4	1.40	22.4	1.05	61.0	18.7	2.30	21.3	1.75	22.5	1.40	22.5	1.05	
58.0	20.2	2.45	22.5	1.70	23.6	1.40			58.0	20.3	2.10	22.7	1.60	23.7	1.40			
55.0	21.7	2.30	23.9	1.65	24.7	1.35			55.0	21.8	1.95	23.9	1.55	24.8	1.35			
52.0	23.2	2.15	25.1	1.60	25.8	1.35			52.0	23.3	1.75	25.2	1.45	25.9	1.35			
50.0	24.1	2.05	26.0	1.60	26.5	1.35			50.0	24.2	1.65	26.0	1.35	26.5	1.35			
48.0	25.1	2.00	26.8	1.55	27.1	1.30			48.0	25.1	1.60	26.8	1.35	27.1	1.30			
46.0	25.9	1.80	27.5	1.50	27.7	1.30			46.0	26.0	1.55	27.5	1.30	27.7	1.30			
44.0	26.7	1.60	28.2	1.50					44.0	26.8	1.45	28.2	1.25					
42.0	27.5	1.45	28.9	1.35					42.0	27.6	1.40	28.9	1.25					
40.0	28.3	1.30	29.5	1.25					40.0	28.4	1.35	29.5	1.20					
35.0	30.0	0.95	30.9	0.95					35.0	30.1	1.15	30.9	1.10					
30.0	31.4	0.75	32.0	0.75					30.0	31.6	1.05	32.1	1.00					
25.0	32.7	0.55							25.0	32.8	0.95							
22.0	33.3	0.45							20.0	33.7	0.90							
									15.0	34.4	0.80							
									10.0	34.8	0.75							
[°]	ブーム2 (%)	100								ブーム2 (%)	0							
	ブーム3 (%)	33								ブーム3 (%)	66							
	ブーム4 (%)	33								ブーム4 (%)	66							
	ブーム5 (%)	33								ブーム5 (%)	66							
	MODE	A								MODE	B							
危険角度 [°]	21	29	45	60					[°]	9	29	45	60					
標準フック [ton]	5.6								[ton]	5.6								
フック質量 [kg]	120								[kg]	120								
巻掛本数 [本]	1								[本]	1								

 ブーム	 ジブ 12.7m	 アウトリガ 7.6m	 作業範囲
--	---	--	---

 [m]	40.0							
	5		25		45		60	
	 [m]	 [ton]	 [m]	 [ton]	 [m]	 [ton]	 [m]	 [ton]
84.0	6.5	2.80	11.2	2.65	13.7	1.75	14.6	1.10
80.0	10.9	2.75	15.1	2.45	17.2	1.65	17.9	1.05
77.0	14.0	2.70	17.8	2.20	19.7	1.60	20.2	1.05
75.0	16.1	2.65	19.5	2.05	21.3	1.55	21.7	1.05
72.0	19.0	2.60	22.0	1.85	23.7	1.50	23.9	1.05
70.0	20.9	2.40	23.6	1.70	25.2	1.40	25.3	1.05
67.0	23.3	1.95	25.9	1.55	27.3	1.30	27.4	1.05
65.0	24.8	1.75	27.4	1.40	28.7	1.25	28.7	1.05
63.0	26.4	1.60	28.9	1.30	30.1	1.15	29.9	1.00
61.0	27.9	1.40	30.3	1.20	31.3	1.10		
58.0	29.9	1.05	32.3	0.90	33.1	0.90		
55.0	31.9	0.70	34.0	0.65	34.6	0.65		
53.0	33.2	0.55						
	ブーム2 (%)	100						
	ブーム3 (%)	100						
	ブーム4 (%)	100						
	ブーム5 (%)	100						
	MODE	A,B						
危険角度	[°]	52	54	54	54	54	62	
標準フック	[ton]	5.6						
フック質量	[kg]	120						
巻掛本数	[本]	1						

















SL-600RfII ブーム + SLジブ定格総荷重表



[m]	25.1								25.0									
	5		25		45		60		[°]	5		25		45		60		
	[m]	[ton]	[m]	[ton]	[m]	[ton]	[m]	[ton]		[m]	[ton]	[m]	[ton]	[m]	[ton]	[m]	[ton]	
84.0	3.8	2.80	7.9	2.65	10.8	1.80	12.0	1.15	84.0	3.9	2.80	8.2	2.65	11.0	1.75	12.2	1.15	
80.0	6.5	2.80	10.4	2.60	13.1	1.65	14.1	1.15	80.0	6.7	2.80	10.7	2.60	13.3	1.65	14.3	1.15	
77.0	8.5	2.75	12.3	2.45	14.7	1.65	15.5	1.15	77.0	8.7	2.75	12.5	2.40	14.9	1.65	15.7	1.15	
75.0	9.9	2.75	13.5	2.35	15.7	1.60	16.5	1.10	75.0	10.1	2.75	13.7	2.30	15.9	1.60	16.7	1.10	
72.0	11.8	2.70	15.5	2.15	17.3	1.50	17.9	1.10	72.0	12.0	2.70	15.4	2.15	17.4	1.50	18.0	1.10	
70.0	13.1	2.70	16.8	2.10	18.2	1.50	18.8	1.10	70.0	13.3	2.70	16.6	2.10	18.4	1.50	18.9	1.10	
67.0	15.0	2.70	18.4	1.95	19.7	1.45	20.0	1.10	67.0	15.2	2.65	18.2	1.95	19.8	1.45	20.2	1.10	
65.0	16.2	2.65	19.3	1.90	20.6	1.45	20.9	1.10	65.0	16.4	2.60	19.3	1.90	20.7	1.45	21.0	1.10	
63.0	17.4	2.60	20.2	1.80	21.5	1.40	21.6	1.10	63.0	17.6	2.50	20.3	1.80	21.6	1.40	21.7	1.10	
61.0	18.5	2.60	21.1	1.75	22.4	1.40	22.4	1.05	61.0	18.7	2.30	21.3	1.75	22.5	1.40	22.5	1.05	
58.0	20.2	2.45	22.5	1.70	23.6	1.40			58.0	20.3	2.10	22.7	1.60	23.7	1.40			
55.0	21.7	2.30	23.9	1.65	24.7	1.35			55.0	21.8	1.95	23.9	1.55	24.8	1.35			
52.0	23.2	2.15	25.1	1.60	25.8	1.35			52.0	23.3	1.75	25.2	1.45	25.9	1.35			
50.0	24.1	1.95	26.0	1.60	26.5	1.35			50.0	24.2	1.65	26.0	1.35	26.5	1.35			
48.0	25.0	1.75	26.8	1.55	27.1	1.30			48.0	25.1	1.60	26.8	1.35	27.1	1.30			
46.0	25.9	1.55	27.5	1.45	27.7	1.30			46.0	26.0	1.55	27.5	1.30	27.7	1.30			
44.0	26.7	1.35	28.2	1.30					44.0	26.8	1.45	28.2	1.25					
42.0	27.5	1.20	28.9	1.15					42.0	27.6	1.40	28.9	1.25					
40.0	28.3	1.05	29.5	1.00					40.0	28.4	1.35	29.5	1.20					
35.0	29.9	0.75	30.8	0.75					35.0	30.1	1.15	30.9	1.10					
30.0	31.4	0.55	32.0	0.55					30.0	31.6	1.05	32.1	1.00					
28.0	32.0	0.45							25.0	32.8	0.95							
									20.0	33.7	0.90							
									15.0	34.4	0.80							
									10.0	34.8	0.75							
[°]	ブーム2 (%)	100								ブーム2 (%)	0							
	ブーム3 (%)	33								ブーム3 (%)	66							
	ブーム4 (%)	33								ブーム4 (%)	66							
	ブーム5 (%)	33								ブーム5 (%)	66							
	MODE	A								MODE	B							
危険角度 [°]	27	29	45	60					[°]	9	29	45	60					
標準フック [ton]	5.6								[ton]	5.6								
フック質量 [kg]	120								[kg]	120								
巻掛本数 [本]	1								[本]	1								















ブーム 	ジブ  12.7m	アウトリガ  7.2m	作業範囲 
--	---	--	---

 [m]	40.0							
	5		25		45		60	
								
 [°]	[m]	[ton]	[m]	[ton]	[m]	[ton]	[m]	[ton]
84.0	6.5	2.80	11.2	2.65	13.7	1.75	14.6	1.10
80.0	10.9	2.75	15.1	2.45	17.2	1.65	17.9	1.05
77.0	14.0	2.70	17.8	2.20	19.7	1.60	20.2	1.05
75.0	16.1	2.65	19.5	2.05	21.3	1.55	21.7	1.05
72.0	19.0	2.60	22.0	1.85	23.7	1.50	23.9	1.05
70.0	20.9	2.40	23.6	1.70	25.2	1.40	25.3	1.05
67.0	23.3	1.95	25.9	1.55	27.3	1.30	27.4	1.05
65.0	24.8	1.75	27.4	1.40	28.7	1.25	28.7	1.05
63.0	26.4	1.50	28.9	1.30	30.1	1.15	29.9	1.00
61.0	27.7	1.20	30.3	1.05	31.3	1.05		
58.0	29.7	0.85	32.0	0.75	32.9	0.75		
56.0	31.0	0.65						
	ブーム2 (%)	100						
	ブーム3 (%)	100						
	ブーム4 (%)	100						
	ブーム5 (%)	100						
	MODE	A,B						
 危険角度	[°]	55	57	57	62			
 標準フック	[ton]	5.6						
 フック質量	[kg]	120						
 巻掛本数	[本]	1						



[m]	25.1								25.0								
	5		25		45		60		[°]	5		25		45		60	
	[m]	[ton]	[m]	[ton]	[m]	[ton]	[m]	[ton]		[m]	[ton]	[m]	[ton]	[m]	[ton]	[m]	[ton]
84.0	3.8	2.80	7.9	2.65	10.8	1.80	12.0	1.15	84.0	3.9	2.80	8.2	2.65	11.0	1.75	12.2	1.15
80.0	6.5	2.80	10.4	2.60	13.1	1.65	14.1	1.15	80.0	6.7	2.80	10.7	2.60	13.3	1.65	14.3	1.15
77.0	8.5	2.75	12.3	2.45	14.7	1.65	15.5	1.15	77.0	8.7	2.75	12.5	2.40	14.9	1.65	15.7	1.15
75.0	9.9	2.75	13.5	2.35	15.7	1.60	16.5	1.10	75.0	10.1	2.75	13.7	2.30	15.9	1.60	16.7	1.10
72.0	11.8	2.70	15.5	2.15	17.3	1.50	17.9	1.10	72.0	12.0	2.70	15.4	2.15	17.4	1.50	18.0	1.10
70.0	13.1	2.70	16.8	2.10	18.2	1.50	18.8	1.10	70.0	13.3	2.70	16.6	2.10	18.4	1.50	18.9	1.10
67.0	15.0	2.70	18.4	1.95	19.7	1.45	20.0	1.10	67.0	15.2	2.65	18.2	1.95	19.8	1.45	20.2	1.10
65.0	16.2	2.65	19.3	1.90	20.6	1.45	20.9	1.10	65.0	16.4	2.60	19.3	1.90	20.7	1.45	21.0	1.10
63.0	17.4	2.60	20.2	1.80	21.5	1.40	21.6	1.10	63.0	17.6	2.50	20.3	1.80	21.6	1.40	21.7	1.10
61.0	18.5	2.60	21.1	1.75	22.4	1.40	22.4	1.05	61.0	18.7	2.30	21.3	1.75	22.5	1.40	22.5	1.05
58.0	20.2	2.45	22.5	1.70	23.6	1.40			58.0	20.3	2.10	22.7	1.60	23.7	1.40		
55.0	21.7	2.10	23.9	1.65	24.7	1.35			55.0	21.8	1.95	23.9	1.55	24.8	1.35		
52.0	23.1	1.70	25.1	1.50	25.8	1.35			52.0	23.3	1.75	25.2	1.45	25.9	1.35		
50.0	24.0	1.45	26.0	1.35	26.5	1.35			50.0	24.2	1.65	26.0	1.35	26.5	1.35		
48.0	24.9	1.25	26.7	1.15	27.0	1.15			48.0	25.1	1.60	26.8	1.35	27.1	1.30		
46.0	25.7	1.10	27.4	1.00	27.6	1.00			46.0	26.0	1.55	27.5	1.30	27.7	1.30		
44.0	26.5	0.95	28.1	0.85					44.0	26.8	1.45	28.2	1.25				
42.0	27.3	0.80	28.8	0.75					42.0	27.6	1.40	28.9	1.25				
40.0	28.0	0.65	29.4	0.65					40.0	28.4	1.30	29.5	1.20				
37.0	29.1	0.50	30.2	0.50					35.0	30.1	1.05	30.8	1.05				
									30.0	31.5	0.85	32.0	0.85				
									25.0	32.7	0.65						
									20.0	33.7	0.55						
									15.0	34.4	0.50						
									12.0	34.7	0.45						
ブーム2 (%)	100								ブーム2 (%)	0							
	ブーム3 (%)								33								
	ブーム4 (%)								33								
	ブーム5 (%)								33								
	MODE								A								
危険角度 [°]	36		36		45		60		[°]	11		29		45		60	
標準フック [ton]	5.6								[ton]	5.6							
フック質量 [kg]	120								[kg]	120							
巻掛本数 [本]	1								[本]	1							











 ブーム	 ジブ 12.7m	 アウトリガ 6.5m	 作業範囲
--	---	--	---

 [m]	40.0								
	5		25		45		60		
	 [°]	 [m]	 [ton]	 [°]	 [m]	 [ton]	 [°]	 [m]	 [ton]
84.0	6.5	2.80	11.2	2.65	13.7	1.75	14.6	1.10	
80.0	10.9	2.75	15.1	2.45	17.2	1.65	17.9	1.05	
77.0	14.0	2.70	17.8	2.20	19.7	1.60	20.2	1.05	
75.0	16.1	2.65	19.5	2.05	21.3	1.55	21.7	1.05	
72.0	19.0	2.60	22.0	1.85	23.7	1.50	23.9	1.05	
70.0	20.9	2.40	23.6	1.70	25.2	1.40	25.3	1.05	
67.0	23.3	1.70	25.9	1.50	27.3	1.30	27.4	1.05	
65.0	24.5	1.40	27.4	1.15	28.7	1.10	28.7	1.05	
63.0	25.9	1.10	28.6	0.95	30.1	0.85	29.9	0.85	
61.0	27.3	0.85							
	ブーム2 (%)	100							
	ブーム3 (%)	100							
	ブーム4 (%)	100							
	ブーム5 (%)	100							
	MODE	A,B							
 危険角度	[°]	60	62	62	62				
 標準フック	[ton]	5.6							
 フック質量	[kg]	120							
 巻掛本数	[本]	1							









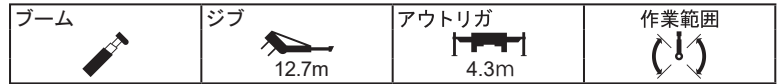















[m]	25.1								25.0									
	5		25		45		60		[°]	5		25		45		60		
	[m]	[ton]	[m]	[ton]	[m]	[ton]	[m]	[ton]		[m]	[ton]	[m]	[ton]	[m]	[ton]	[m]	[ton]	
84.0	3.8	2.80	7.9	2.65	10.8	1.80	12.0	1.15	84.0	3.9	2.80	8.2	2.65	11.0	1.75	12.2	1.15	
80.0	6.5	2.80	10.4	2.60	13.1	1.65	14.1	1.15	80.0	6.7	2.80	10.7	2.60	13.3	1.65	14.3	1.15	
77.0	8.5	2.75	12.3	2.45	14.7	1.65	15.5	1.15	77.0	8.7	2.75	12.5	2.40	14.9	1.65	15.7	1.15	
75.0	9.9	2.75	13.5	2.35	15.7	1.60	16.5	1.10	75.0	10.1	2.75	13.7	2.30	15.9	1.60	16.7	1.10	
72.0	11.8	2.70	15.5	2.15	17.3	1.50	17.9	1.10	72.0	12.0	2.70	15.4	2.15	17.4	1.50	18.0	1.10	
70.0	13.1	2.70	16.8	2.10	18.2	1.50	18.8	1.10	70.0	13.3	2.70	16.6	2.10	18.4	1.50	18.9	1.10	
67.0	15.0	2.70	18.4	1.95	19.7	1.45	20.0	1.10	67.0	15.2	2.65	18.2	1.95	19.8	1.45	20.2	1.10	
65.0	16.2	2.65	19.3	1.90	20.6	1.45	20.9	1.10	65.0	16.4	2.60	19.3	1.90	20.7	1.45	21.0	1.10	
63.0	17.4	2.60	20.2	1.80	21.5	1.40	21.6	1.10	63.0	17.6	2.50	20.3	1.80	21.6	1.40	21.7	1.10	
61.0	18.3	2.25	21.1	1.75	22.4	1.40	22.4	1.05	61.0	18.7	2.30	21.3	1.75	22.5	1.40	22.5	1.05	
58.0	19.9	1.70	22.5	1.40	23.6	1.35			58.0	20.3	2.10	22.7	1.60	23.7	1.40			
55.0	21.4	1.30	23.8	1.10	24.6	1.05			55.0	21.8	1.85	23.9	1.55	24.8	1.35			
52.0	22.9	0.95	25.0	0.80	25.7	0.80			52.0	23.1	1.55	25.2	1.40	25.9	1.35			
50.0	23.8	0.75	25.8	0.65	26.3	0.65			50.0	24.1	1.35	26.0	1.25	26.5	1.25			
48.0	24.7	0.55	26.5	0.50	27.0	0.50			48.0	24.9	1.20	26.7	1.10	27.1	1.10			
47.0	25.1	0.50							46.0	25.8	1.05	27.5	1.00	27.7	1.00			
									44.0	26.6	0.90	28.2	0.85					
									42.0	27.4	0.80	28.8	0.75					
									40.0	28.2	0.70	29.4	0.65					
									35.0	29.9	0.45	30.8	0.45					
[°]	ブーム2 (%)	100								ブーム2 (%)	0							
	ブーム3 (%)	33								ブーム3 (%)	66							
	ブーム4 (%)	33								ブーム4 (%)	66							
	ブーム5 (%)	33								ブーム5 (%)	66							
	MODE	A								MODE	B							
危険角度 [°]	46	47	47	60					危険角度 [°]	34	34	45	60					
標準フック [ton]	5.6								標準フック [ton]	5.6								
フック質量 [kg]	120								フック質量 [kg]	120								
巻掛本数 [本]	1								巻掛本数 [本]	1								















 ブーム	 ジブ 12.7m	 アウトリガ 5.4m	 作業範囲
--	---	--	---

 [m]	40.0							
	5		25		45		60	
 [°]								
	[m]	[ton]	[m]	[ton]	[m]	[ton]	[m]	[ton]
84.0	6.5	2.80	11.2	2.65	13.7	1.75	14.6	1.10
80.0	10.9	2.75	15.1	2.45	17.2	1.65	17.9	1.05
77.0	14.0	2.70	17.8	2.20	19.7	1.60	20.2	1.05
75.0	16.1	2.65	19.5	2.05	21.3	1.55	21.7	1.05
72.0	19.0	2.00	22.0	1.70	23.7	1.50	23.9	1.05
70.0	20.2	1.65	23.3	1.35	25.2	1.20	25.3	1.05
68.0	21.7	1.25						
	ブーム2 (%)	100						
	ブーム3 (%)	100						
	ブーム4 (%)	100						
	ブーム5 (%)	100						
	MODE	A,B						
 危険角度	[°]	67	69	69	69	69	69	69
 標準フック	[ton]	5.6						
 フック質量	[kg]	120						
 巻掛本数	[本]	1						



 [m]	25.1								25.0									
	5		25		45		60		[°]	5		25		45		60		
	 [m]	 [ton]	 [m]	 [ton]	 [m]	 [ton]	 [m]	 [ton]		 [m]	 [ton]	 [m]	 [ton]	 [m]	 [ton]	 [m]	 [ton]	
84.0	3.8	2.80	7.9	2.65	10.8	1.80	12.0	1.15	84.0	3.9	2.80	8.2	2.65	11.0	1.75	12.2	1.15	
80.0	6.5	2.80	10.4	2.60	13.1	1.65	14.1	1.15	80.0	6.7	2.80	10.7	2.60	13.3	1.65	14.3	1.15	
77.0	8.5	2.75	12.3	2.45	14.7	1.65	15.5	1.15	77.0	8.7	2.75	12.5	2.40	14.9	1.65	15.7	1.15	
75.0	9.9	2.75	13.5	2.35	15.7	1.60	16.5	1.10	75.0	10.1	2.75	13.7	2.30	15.9	1.60	16.7	1.10	
72.0	11.8	2.70	15.5	2.15	17.3	1.50	17.9	1.10	72.0	12.0	2.70	15.4	2.15	17.4	1.50	18.0	1.10	
70.0	13.1	2.70	16.8	2.10	18.2	1.50	18.8	1.10	70.0	13.3	2.70	16.6	2.10	18.4	1.50	18.9	1.10	
67.0	14.9	2.45	18.3	1.75	19.7	1.45	20.0	1.10	67.0	15.2	2.65	18.2	1.95	19.8	1.45	20.2	1.10	
65.0	16.0	2.00	19.2	1.50	20.6	1.40	20.9	1.10	65.0	16.4	2.45	19.3	1.90	20.7	1.45	21.0	1.10	
63.0	17.1	1.60	20.0	1.25	21.4	1.15	21.6	1.10	63.0	17.6	2.10	20.3	1.75	21.6	1.40	21.7	1.10	
61.0	18.2	1.25	20.9	1.00	22.2	0.95	22.3	0.95	61.0	18.6	1.80	21.2	1.50	22.5	1.40	22.5	1.05	
59.0	19.2	1.00	21.8	0.80	23.0	0.75			58.0	20.1	1.45	22.5	1.20	23.6	1.15			
58.0	19.7	0.85							55.0	21.5	1.10	23.8	0.95	24.7	0.95			
									52.0	22.9	0.85	25.0	0.75	25.7	0.75			
									50.0	23.9	0.70	25.8	0.60	26.4	0.60			
									48.0	24.8	0.55	26.6	0.50	27.0	0.50			
									47.0	25.2	0.45							
	ブーム2 (%)	100								ブーム2 (%)	0							
	ブーム3 (%)	33								ブーム3 (%)	66							
	ブーム4 (%)	33								ブーム4 (%)	66							
	ブーム5 (%)	33								ブーム5 (%)	66							
	MODE	A								MODE	B							
 危険角度 [°]	57	58	58	60					[°]	46	47	47	60					
 標準フック [ton]	5.6								[ton]	5.6								
 フック質量 [kg]	120								[kg]	120								
 巻掛本数 [本]	1								[本]	1								

 ブーム	 ジブ 12.7m	 アウトリガ 4.3m	 作業範囲
--	---	--	---

 [m]	40.0							
	5		25		45		60	
 [°]	 [m]	 [ton]	 [m]	 [ton]	 [m]	 [ton]	 [m]	 [ton]
	84.0	6.5	2.80	11.2	2.65	13.7	1.75	14.6
80.0	10.9	2.75	15.1	2.45	17.2	1.65	17.9	1.05
77.0	14.0	2.65	17.8	1.95	19.7	1.60	20.2	1.05
75.0	15.7	2.00	19.1	1.55	21.3	1.35	21.7	1.05
73.0	17.2	1.50						
	ブーム2 (%)	100						
	ブーム3 (%)	100						
	ブーム4 (%)	100						
	ブーム5 (%)	100						
	MODE	A,B						
 危険角度	[°]	72	74	74	74	74	74	74
 標準フック	[ton]	5.6						
 フック質量	[kg]	120						
 巻掛本数	[本]	1						





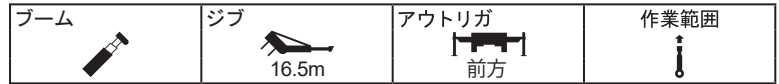







SL-600RfII ブーム + SLジブ定格総荷重表









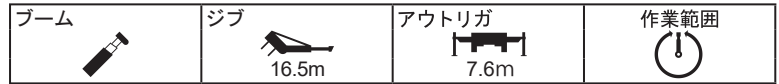











[m]	25.1								25.0									
	5		25		45		60		[°]	5		25		45		60		
	[m]	[ton]	[m]	[ton]	[m]	[ton]	[m]	[ton]		[m]	[ton]	[m]	[ton]	[m]	[ton]	[m]	[ton]	
84.0	4.5	2.00	9.8	1.25	13.7	0.75	15.5	0.60	84.0	4.8	2.00	10.2	1.20	13.9	0.75	15.7	0.60	
80.0	7.5	2.00	12.5	1.10	16.1	0.70	17.7	0.60	80.0	7.8	2.00	12.9	1.10	16.4	0.70	17.9	0.60	
77.0	9.8	1.85	14.5	1.00	17.9	0.70	19.3	0.60	77.0	10.1	1.80	14.9	1.00	18.1	0.70	19.4	0.60	
75.0	11.2	1.70	15.9	0.95	19.0	0.70	20.2	0.60	75.0	11.5	1.65	16.1	0.95	19.2	0.65	20.3	0.60	
72.0	13.4	1.50	17.7	0.90	20.6	0.65	21.7	0.60	72.0	13.7	1.50	18.0	0.85	20.8	0.65	21.7	0.60	
70.0	14.7	1.40	19.0	0.85	21.7	0.65	22.5	0.60	70.0	15.0	1.35	19.2	0.85	21.8	0.65	22.6	0.60	
67.0	16.8	1.30	20.8	0.80	23.2	0.60	23.8	0.55	67.0	17.0	1.25	21.0	0.80	23.3	0.60	23.9	0.55	
65.0	18.1	1.15	21.9	0.80	24.2	0.60	24.6	0.55	65.0	18.3	1.15	22.1	0.75	24.3	0.60	24.7	0.55	
63.0	19.4	1.10	23.0	0.75	25.1	0.60	25.4	0.55	63.0	19.6	1.10	23.2	0.75	25.2	0.60	25.5	0.55	
61.0	20.6	1.05	24.1	0.70	26.0	0.60	26.2	0.50	61.0	20.8	1.05	24.3	0.70	26.1	0.60	26.2	0.50	
58.0	22.4	0.95	25.7	0.70	27.3	0.55			58.0	22.6	0.95	25.8	0.70	27.3	0.55			
55.0	24.1	0.90	27.2	0.65	28.4	0.55			55.0	24.3	0.90	27.3	0.65	28.5	0.55			
52.0	25.7	0.90	28.5	0.65	29.5	0.55			52.0	25.9	0.90	28.6	0.65	29.6	0.55			
50.0	26.8	0.85	29.4	0.65	30.2	0.55			50.0	26.9	0.85	29.5	0.65	30.2	0.55			
48.0	27.8	0.85	30.3	0.60	30.8	0.55			48.0	27.9	0.85	30.4	0.60	30.9	0.55			
46.0	28.8	0.80	31.1	0.60	31.5	0.50			46.0	28.9	0.80	31.2	0.60	31.5	0.50			
44.0	29.7	0.75	31.8	0.60					44.0	29.8	0.75	31.9	0.60					
42.0	30.6	0.75	32.5	0.60					42.0	30.7	0.75	32.6	0.60					
40.0	31.5	0.70	33.2	0.60					40.0	31.6	0.70	33.2	0.60					
35.0	33.4	0.65	34.7	0.60					35.0	33.5	0.65	34.7	0.60					
30.0	35.1	0.60	35.8	0.60					30.0	35.2	0.60	35.8	0.60					
25.0	36.5	0.60							25.0	36.5	0.60							
20.0	37.6	0.60							20.0	37.6	0.60							
15.0	38.3	0.55							15.0	38.3	0.55							
10.0	38.7	0.50							10.0	38.7	0.50							
 ブーム2 (%) ブーム3 (%) ブーム4 (%) ブーム5 (%) MODE	100								0									
	33								66									
	33								66									
	33								66									
	A								B									
 危険角度	[°]	9	29	45	60	[°]	9	29	45	60								
 標準フック	[ton]	5.6								[ton]	5.6							
 フック質量	[kg]	120								[kg]	120							
 巻掛本数	[本]	1								[本]	1							















 ブーム	 ジブ 16.5m	 アウトリガ 前方	 作業範囲
--	---	--	---

 [m]	40.0								
	5		25		45		60		
	 [°]	 [m]	 [ton]	 [m]	 [ton]	 [m]	 [ton]	 [m]	 [ton]
84.0	7.3	2.00	12.7	1.15	16.5	0.70	17.9	0.60	
80.0	11.9	1.90	16.7	1.05	20.1	0.70	21.3	0.60	
77.0	15.3	1.65	19.7	0.95	22.6	0.65	23.6	0.60	
75.0	17.3	1.50	21.7	0.90	24.2	0.60	25.1	0.55	
72.0	20.3	1.30	24.4	0.85	26.7	0.60	27.3	0.55	
70.0	22.3	1.25	26.2	0.80	28.3	0.60	28.8	0.55	
67.0	25.0	1.15	28.7	0.75	30.6	0.60	30.8	0.55	
65.0	26.8	1.10	30.4	0.75	32.0	0.60	32.1	0.55	
63.0	28.6	1.05	32.0	0.75	33.4	0.55	33.3	0.50	
61.0	30.3	1.00	33.5	0.70	34.7	0.55			
58.0	32.6	0.95	35.7	0.70	36.6	0.55			
55.0	35.1	0.85	37.7	0.65	38.4	0.55			
52.0	37.3	0.75	39.7	0.65	40.1	0.55			
50.0	38.7	0.65	40.8	0.55	41.1	0.50			
48.0	40.0	0.55	41.9	0.50	42.0	0.45			
	ブーム2 (%)	100							
	ブーム3 (%)	100							
	ブーム4 (%)	100							
	ブーム5 (%)	100							
	MODE	A,B							
危険角度	[°]	47	47	47	47	47	62		
標準フック	[ton]	5.6							
フック質量	[kg]	120							
巻掛本数	[本]	1							



 [m]	25.1								25.0									
	5		25		45		60		[°]	5		25		45		60		
	 [m]	 [ton]	 [m]	 [ton]	 [m]	 [ton]	 [m]	 [ton]		 [m]	 [ton]	 [m]	 [ton]	 [m]	 [ton]	 [m]	 [ton]	
84.0	4.5	2.00	9.8	1.25	13.7	0.75	15.5	0.60	84.0	4.8	2.00	10.2	1.20	13.9	0.75	15.7	0.60	
80.0	7.5	2.00	12.5	1.10	16.1	0.70	17.7	0.60	80.0	7.8	2.00	12.9	1.10	16.4	0.70	17.9	0.60	
77.0	9.8	1.85	14.5	1.00	17.9	0.70	19.3	0.60	77.0	10.1	1.80	14.9	1.00	18.1	0.70	19.4	0.60	
75.0	11.2	1.70	15.9	0.95	19.0	0.70	20.2	0.60	75.0	11.5	1.65	16.1	0.95	19.2	0.65	20.3	0.60	
72.0	13.4	1.50	17.7	0.90	20.6	0.65	21.7	0.60	72.0	13.7	1.50	18.0	0.85	20.8	0.65	21.7	0.60	
70.0	14.7	1.40	19.0	0.85	21.7	0.65	22.5	0.60	70.0	15.0	1.35	19.2	0.85	21.8	0.65	22.6	0.60	
67.0	16.8	1.30	20.8	0.80	23.2	0.60	23.8	0.55	67.0	17.0	1.25	21.0	0.80	23.3	0.60	23.9	0.55	
65.0	18.1	1.15	21.9	0.80	24.2	0.60	24.6	0.55	65.0	18.3	1.15	22.1	0.75	24.3	0.60	24.7	0.55	
63.0	19.4	1.10	23.0	0.75	25.1	0.60	25.4	0.55	63.0	19.6	1.10	23.2	0.75	25.2	0.60	25.5	0.55	
61.0	20.6	1.05	24.1	0.70	26.0	0.60	26.2	0.50	61.0	20.8	1.05	24.3	0.70	26.1	0.60	26.2	0.50	
58.0	22.4	0.95	25.7	0.70	27.3	0.55			58.0	22.6	0.95	25.8	0.70	27.3	0.55			
55.0	24.1	0.90	27.2	0.65	28.4	0.55			55.0	24.3	0.90	27.3	0.65	28.5	0.55			
52.0	25.7	0.90	28.5	0.65	29.5	0.55			52.0	25.9	0.90	28.6	0.65	29.6	0.55			
50.0	26.8	0.85	29.4	0.65	30.2	0.55			50.0	26.9	0.85	29.5	0.65	30.2	0.55			
48.0	27.8	0.85	30.3	0.60	30.8	0.55			48.0	27.9	0.85	30.4	0.60	30.9	0.55			
46.0	28.8	0.80	31.1	0.60	31.5	0.50			46.0	28.9	0.80	31.2	0.60	31.5	0.50			
44.0	29.7	0.75	31.8	0.60					44.0	29.8	0.75	31.9	0.60					
42.0	30.6	0.75	32.5	0.60					42.0	30.7	0.75	32.6	0.60					
40.0	31.5	0.70	33.2	0.60					40.0	31.6	0.70	33.2	0.60					
35.0	33.4	0.65	34.7	0.60					35.0	33.5	0.65	34.7	0.60					
30.0	35.1	0.60	35.8	0.60					30.0	35.2	0.60	35.8	0.60					
26.0	36.2	0.45	36.6	0.45					25.0	36.5	0.60							
									20.0	37.6	0.60							
									15.0	38.3	0.55							
									10.0	38.7	0.50							
	ブーム2 (%)	100								ブーム2 (%)	0							
	ブーム3 (%)	33								ブーム3 (%)	66							
	ブーム4 (%)	33								ブーム4 (%)	66							
	ブーム5 (%)	33								ブーム5 (%)	66							
	MODE	A								MODE	B							
危険角度	[°]	25	25	45	60	[°]	9	29	45	60								
標準フック	[ton]	5.6								[ton]	5.6							
フック質量	[kg]	120								[kg]	120							
巻掛本数	[本]	1								[本]	1							











 ブーム	 ジブ 16.5m	 アウトリガ 7.6m	 作業範囲
--	---	--	---

 [m]	40.0								
	5		25		45		60		
 [°]									
	 [m]	 [ton]	 [m]	 [ton]	 [m]	 [ton]	 [m]	 [ton]	
84.0	7.3	2.00	12.7	1.15	16.5	0.70	17.9	0.60	
80.0	11.9	1.90	16.7	1.05	20.1	0.70	21.3	0.60	
77.0	15.3	1.65	19.7	0.95	22.6	0.65	23.6	0.60	
75.0	17.3	1.50	21.7	0.90	24.2	0.60	25.1	0.55	
72.0	20.3	1.30	24.4	0.85	26.7	0.60	27.3	0.55	
70.0	22.3	1.25	26.2	0.80	28.3	0.60	28.8	0.55	
67.0	25.0	1.15	28.7	0.75	30.6	0.60	30.8	0.55	
65.0	26.8	1.10	30.4	0.75	32.0	0.60	32.1	0.55	
63.0	28.6	1.05	32.0	0.75	33.4	0.55	33.3	0.50	
61.0	30.3	1.00	33.5	0.70	34.7	0.55			
58.0	32.6	0.85	35.7	0.70	36.6	0.55			
55.0	34.6	0.60	37.7	0.50	38.4	0.50			
54.0	35.3	0.50							
	ブーム2 (%)	100							
	ブーム3 (%)	100							
	ブーム4 (%)	100							
	ブーム5 (%)	100							
	MODE	A,B							
 危険角度	[°]	53	54	54	62				
 標準フック	[ton]	5.6							
 フック質量	[kg]	120							
 巻掛本数	[本]	1							



[m]	25.1								25.0									
	5		25		45		60		[°]	5		25		45		60		
	[m]	[ton]	[m]	[ton]	[m]	[ton]	[m]	[ton]		[m]	[ton]	[m]	[ton]	[m]	[ton]	[m]	[ton]	
84.0	4.5	2.00	9.8	1.25	13.7	0.75	15.5	0.60	84.0	4.8	2.00	10.2	1.20	13.9	0.75	15.7	0.60	
80.0	7.5	2.00	12.5	1.10	16.1	0.70	17.7	0.60	80.0	7.8	2.00	12.9	1.10	16.4	0.70	17.9	0.60	
77.0	9.8	1.85	14.5	1.00	17.9	0.70	19.3	0.60	77.0	10.1	1.80	14.9	1.00	18.1	0.70	19.4	0.60	
75.0	11.2	1.70	15.9	0.95	19.0	0.70	20.2	0.60	75.0	11.5	1.65	16.1	0.95	19.2	0.65	20.3	0.60	
72.0	13.4	1.50	17.7	0.90	20.6	0.65	21.7	0.60	72.0	13.7	1.50	18.0	0.85	20.8	0.65	21.7	0.60	
70.0	14.7	1.40	19.0	0.85	21.7	0.65	22.5	0.60	70.0	15.0	1.35	19.2	0.85	21.8	0.65	22.6	0.60	
67.0	16.8	1.30	20.8	0.80	23.2	0.60	23.8	0.55	67.0	17.0	1.25	21.0	0.80	23.3	0.60	23.9	0.55	
65.0	18.1	1.15	21.9	0.80	24.2	0.60	24.6	0.55	65.0	18.3	1.15	22.1	0.75	24.3	0.60	24.7	0.55	
63.0	19.4	1.10	23.0	0.75	25.1	0.60	25.4	0.55	63.0	19.6	1.10	23.2	0.75	25.2	0.60	25.5	0.55	
61.0	20.6	1.05	24.1	0.70	26.0	0.60	26.2	0.50	61.0	20.8	1.05	24.3	0.70	26.1	0.60	26.2	0.50	
58.0	22.4	0.95	25.7	0.70	27.3	0.55			58.0	22.6	0.95	25.8	0.70	27.3	0.55			
55.0	24.1	0.90	27.2	0.65	28.4	0.55			55.0	24.3	0.90	27.3	0.65	28.5	0.55			
52.0	25.7	0.90	28.5	0.65	29.5	0.55			52.0	25.9	0.90	28.6	0.65	29.6	0.55			
50.0	26.8	0.85	29.4	0.65	30.2	0.55			50.0	26.9	0.85	29.5	0.65	30.2	0.55			
48.0	27.8	0.85	30.3	0.60	30.8	0.55			48.0	27.9	0.85	30.4	0.60	30.9	0.55			
46.0	28.8	0.80	31.1	0.60	31.5	0.50			46.0	28.9	0.80	31.2	0.60	31.5	0.50			
44.0	29.7	0.75	31.8	0.60					44.0	29.8	0.75	31.9	0.60					
42.0	30.6	0.75	32.5	0.60					42.0	30.7	0.75	32.6	0.60					
40.0	31.5	0.70	33.2	0.60					40.0	31.6	0.70	33.2	0.60					
35.0	33.4	0.60	34.7	0.60					35.0	33.5	0.65	34.7	0.60					
31.0	34.7	0.45	35.6	0.45					30.0	35.2	0.60	35.8	0.60					
									25.0	36.5	0.60							
									20.0	37.6	0.60							
									15.0	38.3	0.55							
									10.0	38.7	0.50							
 ブーム2 (%) ブーム3 (%) ブーム4 (%) ブーム5 (%) MODE	100								0									
	33								66									
	33								66									
	33								66									
	A								B									
 危険角度	[°]	30	30	45	60	[°]	9	29	45	60								
 標準フック	[ton]	5.6								[ton]	5.6							
 フック質量	[kg]	120								[kg]	120							
 巻掛本数	[本]	1								[本]	1							

















ブーム 	ジブ  16.5m	アウトリガ  7.2m	作業範囲 
--	---	--	---

 [m]	40.0							
	5		25		45		60	
	 [°]	 [m]	 [ton]	 [m]	 [ton]	 [m]	 [ton]	 [m]
84.0	7.3	2.00	12.7	1.15	16.5	0.70	17.9	0.60
80.0	11.9	1.90	16.7	1.05	20.1	0.70	21.3	0.60
77.0	15.3	1.65	19.7	0.95	22.6	0.65	23.6	0.60
75.0	17.3	1.50	21.7	0.90	24.2	0.60	25.1	0.55
72.0	20.3	1.30	24.4	0.85	26.7	0.60	27.3	0.55
70.0	22.3	1.25	26.2	0.80	28.3	0.60	28.8	0.55
67.0	25.0	1.15	28.7	0.75	30.6	0.60	30.8	0.55
65.0	26.8	1.10	30.4	0.75	32.0	0.60	32.1	0.55
63.0	28.6	1.05	32.0	0.75	33.4	0.55	33.3	0.50
61.0	30.3	1.00	33.5	0.70	34.7	0.55		
58.0	32.6	0.65	35.7	0.60	36.6	0.55		
57.0	33.0	0.60						
	ブーム2 (%)	100						
	ブーム3 (%)	100						
	ブーム4 (%)	100						
	ブーム5 (%)	100						
	MODE	A,B						
危険角度	[°]	56	57	57	57	57	62	
標準フック	[ton]	5.6						
フック質量	[kg]	120						
巻掛本数	[本]	1						



[m]	25.1								25.0									
	5		25		45		60		[°]	5		25		45		60		
	[m]	[ton]	[m]	[ton]	[m]	[ton]	[m]	[ton]		[m]	[ton]	[m]	[ton]	[m]	[ton]	[m]	[ton]	
84.0	4.5	2.00	9.8	1.25	13.7	0.75	15.5	0.60	84.0	4.8	2.00	10.2	1.20	13.9	0.75	15.7	0.60	
80.0	7.5	2.00	12.5	1.10	16.1	0.70	17.7	0.60	80.0	7.8	2.00	12.9	1.10	16.4	0.70	17.9	0.60	
77.0	9.8	1.85	14.5	1.00	17.9	0.70	19.3	0.60	77.0	10.1	1.80	14.9	1.00	18.1	0.70	19.4	0.60	
75.0	11.2	1.70	15.9	0.95	19.0	0.70	20.2	0.60	75.0	11.5	1.65	16.1	0.95	19.2	0.65	20.3	0.60	
72.0	13.4	1.50	17.7	0.90	20.6	0.65	21.7	0.60	72.0	13.7	1.50	18.0	0.85	20.8	0.65	21.7	0.60	
70.0	14.7	1.40	19.0	0.85	21.7	0.65	22.5	0.60	70.0	15.0	1.35	19.2	0.85	21.8	0.65	22.6	0.60	
67.0	16.8	1.30	20.8	0.80	23.2	0.60	23.8	0.55	67.0	17.0	1.25	21.0	0.80	23.3	0.60	23.9	0.55	
65.0	18.1	1.15	21.9	0.80	24.2	0.60	24.6	0.55	65.0	18.3	1.15	22.1	0.75	24.3	0.60	24.7	0.55	
63.0	19.4	1.10	23.0	0.75	25.1	0.60	25.4	0.55	63.0	19.6	1.10	23.2	0.75	25.2	0.60	25.5	0.55	
61.0	20.6	1.05	24.1	0.70	26.0	0.60	26.2	0.50	61.0	20.8	1.05	24.3	0.70	26.1	0.60	26.2	0.50	
58.0	22.4	0.95	25.7	0.70	27.3	0.55			58.0	22.6	0.95	25.8	0.70	27.3	0.55			
55.0	24.1	0.90	27.2	0.65	28.4	0.55			55.0	24.3	0.90	27.3	0.65	28.5	0.55			
52.0	25.7	0.90	28.5	0.65	29.5	0.55			52.0	25.9	0.90	28.6	0.65	29.6	0.55			
50.0	26.8	0.85	29.4	0.65	30.2	0.55			50.0	26.9	0.85	29.5	0.65	30.2	0.55			
48.0	27.8	0.85	30.3	0.60	30.8	0.55			48.0	27.9	0.85	30.4	0.60	30.9	0.55			
46.0	28.8	0.80	31.1	0.60	31.5	0.50			46.0	28.9	0.80	31.2	0.60	31.5	0.50			
44.0	29.7	0.75	31.8	0.60					44.0	29.8	0.75	31.9	0.60					
42.0	30.5	0.60	32.5	0.55					42.0	30.7	0.75	32.6	0.60					
40.0	31.4	0.50	33.2	0.50					40.0	31.6	0.70	33.2	0.60					
39.0	31.8	0.45	33.5	0.45					35.0	33.5	0.65	34.7	0.60					
									30.0	35.2	0.60	35.8	0.60					
									25.0	36.5	0.55							
									20.0	37.5	0.45							
[°]	ブーム2 (%)	100								ブーム2 (%)	0							
	ブーム3 (%)	33								ブーム3 (%)	66							
	ブーム4 (%)	33								ブーム4 (%)	66							
	ブーム5 (%)	33								ブーム5 (%)	66							
	MODE	A								MODE	B							
危険角度 [°]	38	38	45	60					[°]	19	29	45	60					
標準フック [ton]	5.6								[ton]	5.6								
フック質量 [kg]	120								[kg]	120								
巻掛本数 [本]	1								[本]	1								











 ブーム	 ジブ 16.5m	 アウトリガ 6.5m	 作業範囲
--	---	--	---

 [m]	40.0							
	5		25		45		60	
 [°]								
	 [°]	[m]	[ton]	[m]	[ton]	[m]	[ton]	[m]
84.0	7.3	2.00	12.7	1.15	16.5	0.70	17.9	0.60
80.0	11.9	1.90	16.7	1.05	20.1	0.70	21.3	0.60
77.0	15.3	1.65	19.7	0.95	22.6	0.65	23.6	0.60
75.0	17.3	1.50	21.7	0.90	24.2	0.60	25.1	0.55
72.0	20.3	1.30	24.4	0.85	26.7	0.60	27.3	0.55
70.0	22.3	1.25	26.2	0.80	28.3	0.60	28.8	0.55
67.0	25.0	1.15	28.7	0.75	30.6	0.60	30.8	0.55
65.0	26.8	1.10	30.4	0.75	32.0	0.60	32.1	0.55
63.0	28.6	0.90	32.0	0.75	33.4	0.55	33.3	0.50
	ブーム2 (%)	100						
	ブーム3 (%)	100						
	ブーム4 (%)	100						
	ブーム5 (%)	100						
	MODE	A,B						
 危険角度	[°]	62	62	62	62	62	62	62
 標準フック	[ton]	5.6						
 フック質量	[kg]	120						
 巻掛本数	[本]	1						









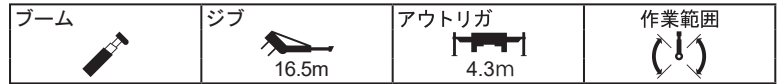















[m]	25.1								25.0									
	5		25		45		60		[°]	5		25		45		60		
	[m]	[ton]	[m]	[ton]	[m]	[ton]	[m]	[ton]		[m]	[ton]	[m]	[ton]	[m]	[ton]	[m]	[ton]	
84.0	4.5	2.00	9.8	1.25	13.7	0.75	15.5	0.60	84.0	4.8	2.00	10.2	1.20	13.9	0.75	15.7	0.60	
80.0	7.5	2.00	12.5	1.10	16.1	0.70	17.7	0.60	80.0	7.8	2.00	12.9	1.10	16.4	0.70	17.9	0.60	
77.0	9.8	1.85	14.5	1.00	17.9	0.70	19.3	0.60	77.0	10.1	1.80	14.9	1.00	18.1	0.70	19.4	0.60	
75.0	11.2	1.70	15.9	0.95	19.0	0.70	20.2	0.60	75.0	11.5	1.65	16.1	0.95	19.2	0.65	20.3	0.60	
72.0	13.4	1.50	17.7	0.90	20.6	0.65	21.7	0.60	72.0	13.7	1.50	18.0	0.85	20.8	0.65	21.7	0.60	
70.0	14.7	1.40	19.0	0.85	21.7	0.65	22.5	0.60	70.0	15.0	1.35	19.2	0.85	21.8	0.65	22.6	0.60	
67.0	16.8	1.30	20.8	0.80	23.2	0.60	23.8	0.55	67.0	17.0	1.25	21.0	0.80	23.3	0.60	23.9	0.55	
65.0	18.1	1.15	21.9	0.80	24.2	0.60	24.6	0.55	65.0	18.3	1.15	22.1	0.75	24.3	0.60	24.7	0.55	
63.0	19.4	1.10	23.0	0.75	25.1	0.60	25.4	0.55	63.0	19.6	1.10	23.2	0.75	25.2	0.60	25.5	0.55	
61.0	20.6	1.05	24.1	0.70	26.0	0.60	26.2	0.50	61.0	20.8	1.05	24.3	0.70	26.1	0.60	26.2	0.50	
58.0	22.4	0.95	25.7	0.70	27.3	0.55			58.0	22.6	0.95	25.8	0.70	27.3	0.55			
55.0	24.1	0.90	27.2	0.65	28.4	0.55			55.0	24.3	0.90	27.3	0.65	28.5	0.55			
52.0	25.7	0.75	28.5	0.65	29.5	0.55			52.0	25.9	0.90	28.6	0.65	29.6	0.55			
50.0	26.7	0.55	29.3	0.50	30.2	0.50			50.0	26.9	0.85	29.5	0.65	30.2	0.55			
48.0	27.7	0.45							48.0	27.9	0.85	30.4	0.60	30.9	0.55			
									46.0	28.9	0.80	31.2	0.60	31.5	0.50			
									44.0	29.8	0.75	31.9	0.60					
									42.0	30.7	0.65	32.6	0.60					
									40.0	31.5	0.55	33.2	0.55					
									38.0	32.3	0.45	33.7	0.45					
[°]	ブーム2 (%)	100								ブーム2 (%)	0							
	ブーム3 (%)	33								ブーム3 (%)	66							
	ブーム4 (%)	33								ブーム4 (%)	66							
	ブーム5 (%)	33								ブーム5 (%)	66							
	MODE	A								MODE	B							
危険角度 [°]	47	49	49	60					危険角度 [°]	37	37	45	60					
標準フック [ton]	5.6								標準フック [ton]	5.6								
フック質量 [kg]	120								フック質量 [kg]	120								
巻掛本数 [本]	1								巻掛本数 [本]	1								











 ブーム	 ジブ 16.5m	 アウトリガ 5.4m	 作業範囲
--	---	--	---



 [m]	40.0							
	5		25		45		60	
 [°]								
	[m]	[ton]	[m]	[ton]	[m]	[ton]	[m]	[ton]
84.0	7.3	2.00	12.7	1.15	16.5	0.70	17.9	0.60
80.0	11.9	1.90	16.7	1.05	20.1	0.70	21.3	0.60
77.0	15.3	1.65	19.7	0.95	22.6	0.65	23.6	0.60
75.0	17.3	1.50	21.7	0.90	24.2	0.60	25.1	0.55
72.0	20.3	1.30	24.4	0.85	26.7	0.60	27.3	0.55
70.0	22.3	1.25	26.2	0.80	28.3	0.60	28.8	0.55
69.0	23.2	1.20						
	ブーム2 (%)	100						
	ブーム3 (%)	100						
	ブーム4 (%)	100						
	ブーム5 (%)	100						
	MODE	A,B						
 危険角度	[°]	68	69	69	69	69	69	69
 標準フック	[ton]	5.6						
 フック質量	[kg]	120						
 巻掛本数	[本]	1						



















 [m]	25.1								25.0									
	5		25		45		60		[°]	5		25		45		60		
	 [°]	 [m]	 [ton]	 [m]	 [ton]	 [m]	 [ton]	 [m]	 [ton]	[°]	 [m]	 [ton]	 [m]	 [ton]	 [m]	 [ton]	 [m]	 [ton]
84.0	4.5	2.00	9.8	1.25	13.7	0.75	15.5	0.60	84.0	4.8	2.00	10.2	1.20	13.9	0.75	15.7	0.60	
80.0	7.5	2.00	12.5	1.10	16.1	0.70	17.7	0.60	80.0	7.8	2.00	12.9	1.10	16.4	0.70	17.9	0.60	
77.0	9.8	1.85	14.5	1.00	17.9	0.70	19.3	0.60	77.0	10.1	1.80	14.9	1.00	18.1	0.70	19.4	0.60	
75.0	11.2	1.70	15.9	0.95	19.0	0.70	20.2	0.60	75.0	11.5	1.65	16.1	0.95	19.2	0.65	20.3	0.60	
72.0	13.4	1.50	17.7	0.90	20.6	0.65	21.7	0.60	72.0	13.7	1.50	18.0	0.85	20.8	0.65	21.7	0.60	
70.0	14.7	1.40	19.0	0.85	21.7	0.65	22.5	0.60	70.0	15.0	1.35	19.2	0.85	21.8	0.65	22.6	0.60	
67.0	16.8	1.30	20.8	0.80	23.2	0.60	23.8	0.55	67.0	17.0	1.25	21.0	0.80	23.3	0.60	23.9	0.55	
65.0	18.1	1.15	21.9	0.80	24.2	0.60	24.6	0.55	65.0	18.3	1.15	22.1	0.75	24.3	0.60	24.7	0.55	
63.0	19.4	1.10	23.0	0.75	25.1	0.60	25.4	0.55	63.0	19.6	1.10	23.2	0.75	25.2	0.60	25.5	0.55	
61.0	20.6	1.00	24.1	0.70	26.0	0.60	26.2	0.50	61.0	20.8	1.05	24.3	0.70	26.1	0.60	26.2	0.50	
59.0	21.6	0.75							58.0	22.6	0.95	25.8	0.70	27.3	0.55			
									55.0	24.3	0.90	27.3	0.65	28.5	0.55			
									52.0	25.9	0.65	28.6	0.55	29.6	0.55			
									50.0	26.8	0.55	29.4	0.45	30.2	0.45			
									49.0	27.2	0.45							
	ブーム2 (%)	100								ブーム2 (%)	0							
	ブーム3 (%)	33								ブーム3 (%)	66							
	ブーム4 (%)	33								ブーム4 (%)	66							
	ブーム5 (%)	33								ブーム5 (%)	66							
	MODE	A								MODE	B							
 危険角度	[°]	58	60	60	60	60	60	60	[°]	48	49	49	49	49	60	60	60	60
 標準フック	[ton]	5.6								[ton]	5.6							
 フック質量	[kg]	120								[kg]	120							
 巻掛本数	[本]	1								[本]	1							

 ブーム	 ジブ 16.5m	 アウトリガ 4.3m	 作業範囲
--	---	--	---

















 [m]		40.0							
		5		25		45		60	
 [°]									
	[m]	[ton]	[m]	[ton]	[m]	[ton]	[m]	[ton]	
84.0	7.3	2.00	12.7	1.15	16.5	0.70	17.9	0.60	
80.0	11.9	1.90	16.7	1.05	20.1	0.70	21.3	0.60	
77.0	15.3	1.65	19.7	0.95	22.6	0.65	23.6	0.60	
75.0	17.3	1.50							
	ブーム2 (%)	100							
	ブーム3 (%)	100							
	ブーム4 (%)	100							
	ブーム5 (%)	100							
	MODE	A,B							
 危険角度	[°]	74	76	76	76	76	76	76	
 標準フック	[ton]	5.6							
 フック質量	[kg]	120							
 巻掛本数	[本]	1							

ブーム 	ジブ	アウトリガ 	作業範囲
--	----	--	------

ブーム [m]		10.1		17.6				25.1		25.0	
作業範囲											
 [m]	3.5	7.00	4.30	7.00	4.00	7.00	4.00	6.00	4.00	6.00	4.00
	4.0	7.00	3.55	7.00	3.40	7.00	4.00	6.00	3.40	6.00	4.00
	4.5	7.00	2.95	7.00	2.80	7.00	3.95	6.00	2.80	6.00	3.95
	5.0	7.00	2.40	7.00	2.30	7.00	3.45	6.00	2.30	6.00	3.45
	5.5	7.00	2.00	7.00	1.85	7.00	3.00	6.00	1.85	6.00	3.00
	6.0	7.00	1.60	7.00	1.50	7.00	2.60	6.00	1.50	6.00	2.60
	6.5	6.50	1.30	6.45	1.15	7.00	2.25	6.00	1.15	6.00	2.25
	7.0	6.00	1.00	5.90	0.90	6.80	1.95	5.90	0.90	6.00	1.95
	7.5			5.45		6.35	1.70	5.45		6.00	1.70
	8.0			5.05		5.95	1.45	5.05		5.95	1.45
	8.5			4.70		5.60	1.25	4.70		5.60	1.25
	9.0			4.35		5.25	1.10	4.35		5.25	1.10
	10.0			3.75		4.65		3.75		4.65	
	11.0			3.25		4.10		3.25		4.10	
12.0			2.80		3.70		2.80		3.70		
13.0			2.45		3.30		2.45		3.30		
14.0			2.10		2.95		2.10		2.95		
	ブーム2 (%)	0		100		0		100		0	
	ブーム3 (%)	0		0		33		33		66	
	ブーム4 (%)	0		0		33		33		66	
	ブーム5 (%)	0		0		33		33		66	
	MODE	A,B		A		B		A		B	
危険角度 	[°]	—	—	—	60	—	50	50	70	50	64
標準フック 	[ton]	34									
フック質量 	[kg]	310									
巻掛本数 	[本]	4									

(単位 : ton)

ブーム 	ジブ	アウトリガ  2km/h未満	作業範囲
--	----	---	------

作業範囲		10.1		17.6				25.1		25.0	
											
 [m]	3.5	5.00	2.70	5.00	2.60	5.00	2.60	5.00	2.60	5.00	2.60
	4.0	5.00	2.20	5.00	2.05	5.00	2.60	5.00	2.05	5.00	2.60
	4.5	5.00	1.70	5.00	1.55	5.00	2.60	5.00	1.55	5.00	2.60
	5.0	5.00	1.30	5.00	1.15	5.00	2.60	5.00	1.15	5.00	2.60
	5.5	5.00	0.95	5.00	0.80	5.00	2.35	5.00	0.80	5.00	2.35
	6.0	4.85		4.75		5.00	2.00	4.75		5.00	2.00
	6.5	4.40		4.30		5.00	1.75	4.30		5.00	1.75
	7.0	4.00		3.95		4.80	1.50	3.95		4.80	1.50
	7.5			3.60		4.45	1.30	3.60		4.45	1.30
	8.0			3.25		4.15	1.10	3.25		4.15	1.10
	8.5			3.00		3.85		3.00		3.85	
	9.0			2.70		3.60		2.70		3.60	
	10.0			2.25		3.15		2.25		3.15	
	11.0			1.90		2.75		1.90		2.75	
	12.0			1.55		2.40		1.55		2.40	
13.0			1.25		2.10		1.25		2.10		
14.0			1.00		1.85		1.00		1.85		
	ブーム2 (%)	0		100		0		100		0	
	ブーム3 (%)	0		0		33		33		66	
	ブーム4 (%)	0		0		33		33		66	
	ブーム5 (%)	0		0		33		33		66	
	MODE	A,B		A		B		A		B	
 危険角度	[°]	—	39	—	66	—	56	50	74	50	67
 標準フック	[ton]	34									
 フック質量	[kg]	310									
 巻掛本数	[本]	4									

(単位 : ton)

最小通路軌跡図

2輪ステアリングで右折する場合

● 60°

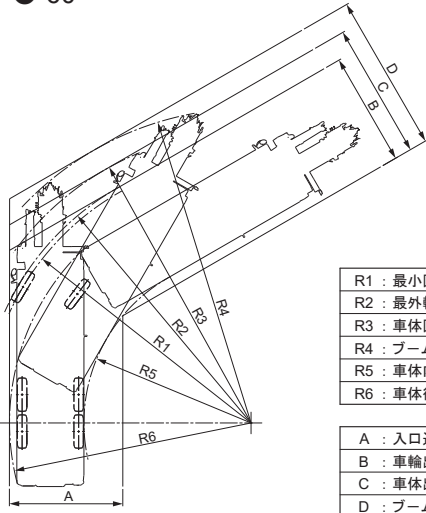

R1 : 最小回転半径	10.80m
R2 : 最外輪端回転半径	11.00m
R3 : 車体回転半径	11.90m
R4 : ブーム先端回転半径	12.80m
R5 : 車体内側回転半径	6.80m
R6 : 車体後端回転半径	9.82m

A : 入口通路幅	4.61m
B : 車輪出口通路幅	4.61m
C : 車体出口通路幅	5.51m
D : ブーム先端出口通路幅	6.41m

6輪ステアリングで右折する場合(構内走行)

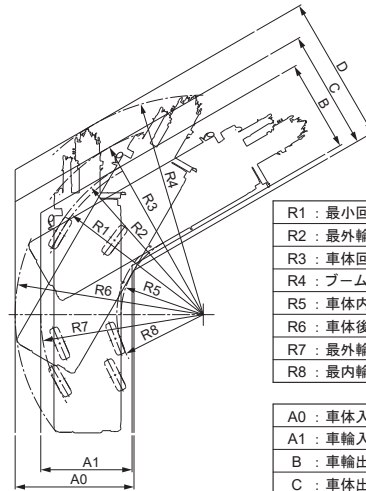

R1 : 最小回転半径	6.70m
R2 : 最外輪端回転半径	6.90m
R3 : 車体回転半径	7.81m
R4 : ブーム先端回転半径	8.93m
R5 : 車体内側回転半径	3.34m
R6 : 車体後端回転半径	7.66m
R7 : 最外輪端回転半径	6.62m
R8 : 最内輪回転半径	3.51m

A0 : 車体入口通路幅	4.84m
A1 : 車輪入口通路幅	3.72m
B : 車輪出口通路幅	3.72m
C : 車体出口通路幅	4.84m
D : ブーム先端出口通路幅	5.96m

● 90°

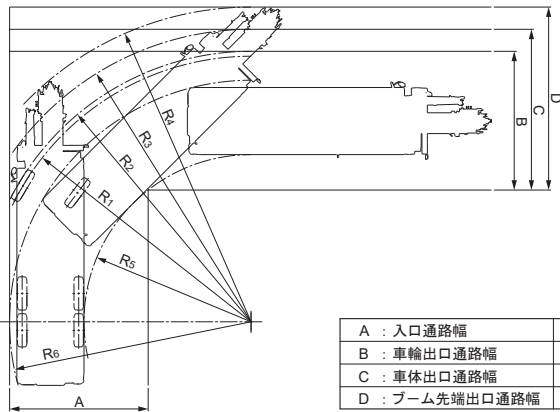

A : 入口通路幅	5.64m
B : 車輪出口通路幅	5.64m
C : 車体出口通路幅	6.54m
D : ブーム先端出口通路幅	7.44m

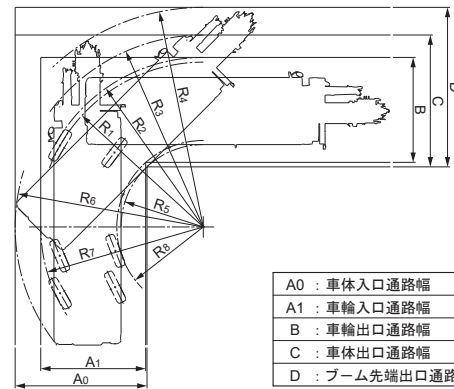

A0 : 車体入口通路幅	5.37m
A1 : 車輪入口通路幅	4.27m
B : 車輪出口通路幅	4.27m
C : 車体出口通路幅	5.37m
D : ブーム先端出口通路幅	6.49m

● 120°

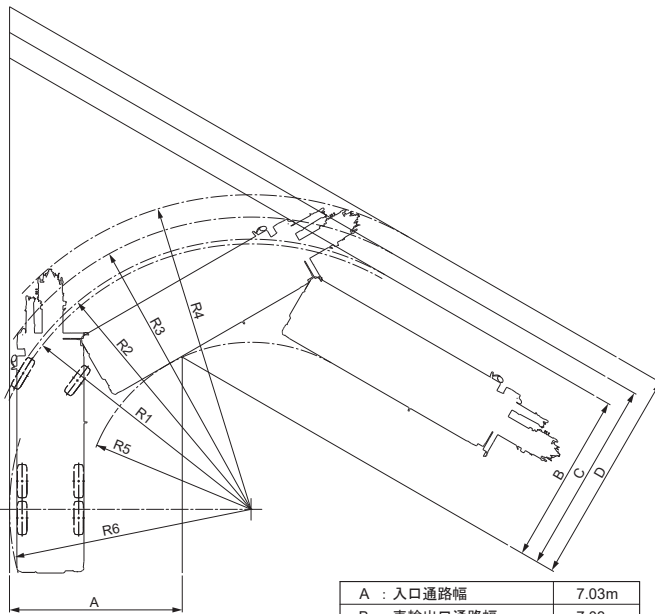

A : 入口通路幅	7.03m
B : 車輪出口通路幅	7.03m
C : 車体出口通路幅	7.93m
D : ブーム先端出口通路幅	8.83m

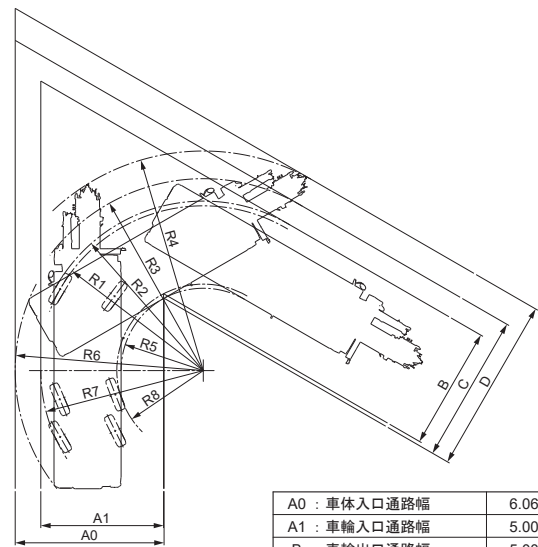

A0 : 車体入口通路幅	6.06m
A1 : 車輪入口通路幅	5.00m
B : 車輪出口通路幅	5.00m
C : 車体出口通路幅	6.06m
D : ブーム先端出口通路幅	7.19m

(注) 上記の数値は計算値です。

■全体図

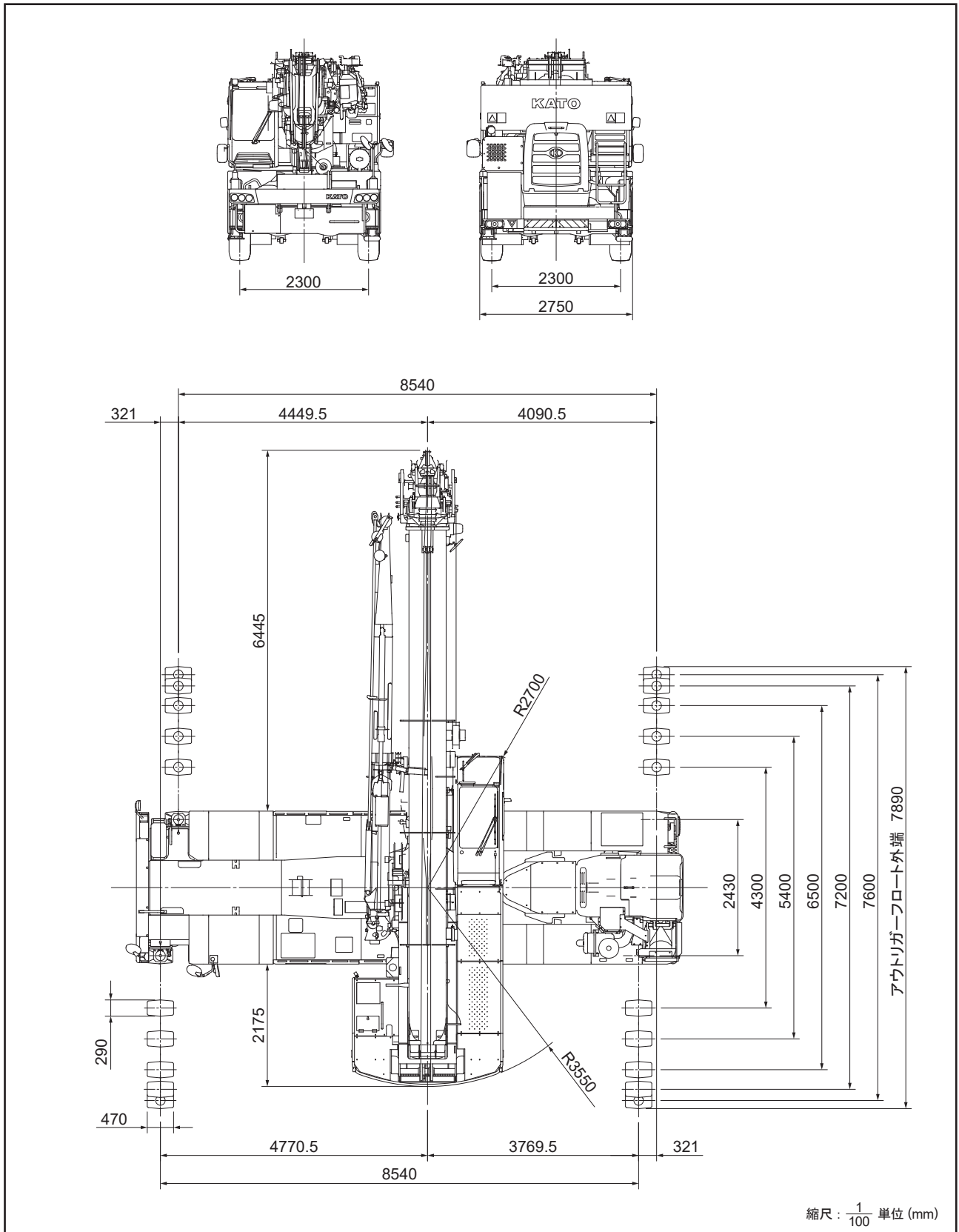

■全体図

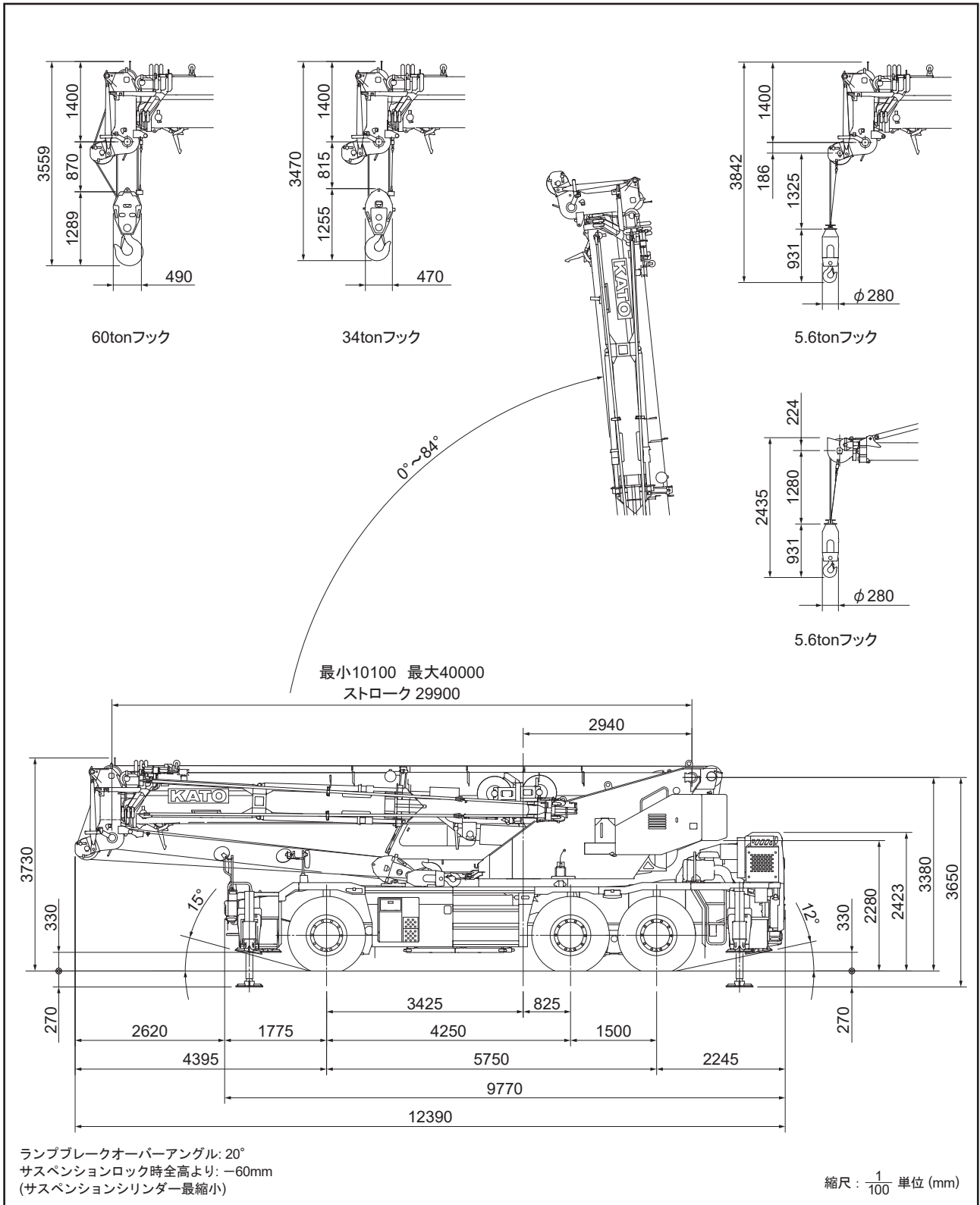

※本カタログに記載されております性能ならびに仕様は、改良などによりお届けいたします製品と異なる場合がありますので、あらかじめご了承ください。

お問い合わせは…

KATO 株式会社 **加藤製作所**

本社 / ☎140-0011 東京都品川区東大井1丁目9番37号
☎03 (3458) 1111番 (大代表)
ホームページアドレス <http://www.kato-works.co.jp>

C05711
10.2021-2500 (TI) 1